



Power Anytime, Anywhere

TI45014D Battery Charger/Conditioner

NSN: 6130-01-625-6382

User Manual



Built Smart...Proven Tough

Tesla Industries, Inc.
101 Centerpoint Blvd.
New Castle, DE 19720
(302) 324-8910 Phone
(302) 324-8912 Fax
www.teslaind.com
www.tesla1.com

NOTE: All users must read this entire manual prior to operating the TI45014D Battery Charger/Conditioner.

The TI45014D Battery Charger/Conditioner is a limited maintenance-free and sealed unit. No repairs are authorized. Warranty will be voided if unit is tampered with in any way, or if unauthorized repairs are made. For technical support please contact:

TESLA™ INDUSTRIES INCORPORATED
101 CENTERPOINT BLVD.
CENTERPOINT INDUSTRIAL PARK, NEW CASTLE, DELAWARE 19720
PHONE: (302) 324-8910 FAX: (302) 324-8912
WEBSITE: www.teslaind.com ♦ www.tesla1.com EMAIL: tesla1@teslaind.com



Improper use or failure to follow instructions in this user manual can result in unit damage and/or injury or death by electrical shock.

Any attempts to open or examine the inside of this unit via a tool or device (borescope, probe, etc.) can result in unit failure and/or injury by electrical shock. This unit is maintenance free and should not be opened or disassembled for any reason.

Always protect the unit from short circuit.

Shipping Hazards: NONE

All Ground Power Units, Micro Power Units (Aviation Batteries) and including, but not limited to, Battery Chargers/Conditioners, manufactured by Tesla™ Industries, Inc., are able to safely and effectively charge any AGM, Lead Acid battery.

The Tesla™ GPU's and chargers are voltage and current regulated to 0.01% (dual loop). The charging voltage is calibrated, by Tesla™, to 28.6 volts and is pure dc (no power line ripple).

Maximum Charge Voltage by Battery Type

Type:	Charging Voltage / Cell	Charging Voltage / 12v	Charging Voltage / 24v
SLI/Flooded	2.366v to 2.416v	14.2v to 14.5v	28.4v to 29v
Lead Acid/Flooded	2.366v to 2.416v	14.2v to 14.5v	28.4v to 29v
Sealed Lead Acid	2.366v to 2.416v	14.2v to 14.5v	28.4v to 29v
VRLA	2.366v to 2.416v	14.2v to 14.5v	28.4v to 29v
AGM	2.433v to 2.466v	14.6v to 14.8v	29.2v to 29.6v
GEL	2.350v to 2.400v	14.1v to 14.4v	28.2v to 28.8v

Table of Contents

Section 1 – Safety Review	1
1.1 – Safety Notices	1
1.2 – Symbols	1
1.3 – Water Hazards	2
1.4 – Important Safety Precautions	2
Section 2 – Product Overview	3
2.1 – Introduction	3
2.2 – Indication of Terms: Shall, Should, and May	3
2.3 – Front and Top Panel Overview	4
2.4 – Rear Panel Overview	5
2.5 – Physical Dimensions	6
2.6 – General Specifications	7
2.7 – Airflow Ports	8
Section 3 – Features Overview	9
3.1 – AC Input Receptacle	9
3.1a – IEC Line Cord Options	9
3.2 – AC Input Selector Switch	9
3.3 – AC Input Circuit Breaker	10
3.4 – DC Output Receptacle	10
3.5 – DC Output Circuit Breakers	11
3.6 – Power Output Indicators	11
3.7 – Integrated Heatsinks	12
3.8 – Mounting Base	12
Section 4 – Pre-Operation Procedures	13
4.1 – Installing the Charger	13
4.2 – Attaching AC Power	13
4.3 – DC Power Cable Assemblies	14
4.4 – Attaching the DC Power Cable	14-15

Section 5 – Operating Procedures	16
5.1 – Before Operation	16
5.2 – Connecting the Battery Charger	16
5.3 – Disconnecting the Battery Charger	17
5.4 – After Operation	17
5.5 – Configurations for 24V	18
5.6 – Configurations for 12V	19
Section 6 – Unit Care and Maintenance	20
6.1 – Unit Care	20
6.2 – Normal Function Test Procedures	21-22
6.3 – Unit Servicing	22
6.4 – Packaging and Shipping	22
Section 7 – Frequently Asked Questions	23
Section 8 – Troubleshooting	24-25
Section 9 – Performance Data	26
9.1 – Purpose	26
9.2 – Explanation of Data	26
9.3 – Definition of Abbreviations	26
9.4 – Performance Graph	27
9.5 – Temperature Conversion Chart	28
Glossary	29
Section 10 - Optional Accessories	30
10.1 – TI2007-070 Mini-DC to Aviation Cable Assembly	30
10.2 – TI2007-071 Mini-DC to Compact NATO Cable Assembly	30
Repair Request Form	31

Abbreviations and Symbols

Abbreviations that may be used within the text, headings and titles of this manual.

LIST OF ABBREVIATIONS



Abbreviation **Definition**

ac	Alternating Current
AFT	Airflow Technology
AWG	American Wire Gauge
amp or A	Ampere
cont	Continuous
°C	Degree Celsius
°F	Degree Fahrenheit
dc	Direct Current
EFF	Efficiency
ft	Feet
FWD	Forward
GPU	Ground Power Unit
Hr	Hour
Hz	Hertz
kg	Kilograms
kHz	Kilohertz
kW	Kilowatts
LED	Light Emitting Diode
max	Maximum
MΩ	megaohm
min	Minimum
MPU	Micro Power Unit
NEMA	National Electrical Manufacturers Association
Ω	ohm
PF	power factor
PFC	power factor correction
rms	root-mean-square
THD	Total Harmonic Distortion
TMDE	Test, Measurement, & Diagnostic Equipment
UAV	Unmanned aerial vehicle
Vac	Volts, Alternating Current
Vdc	Volts, Direct Current
W	watts

Section 1 – Safety Review

1.1 - Safety Notices

Safety notices appear throughout this manual to alert the user to important information regarding proper installation, operation, maintenance and storage of the unit. These notices, as illustrated below, contain a key word that indicates the level of hazard and a triangular icon that indicates the specific type of hazard.

 WARNING	Indicates a condition, operating procedure or practice, which if not adhered to could result in serious injury or death.
 CAUTION	Indicates a condition or operating procedure, which if not strictly adhered to could result in damage or destruction of equipment.
 NOTE	Indicates a condition, operating procedure or practice, which is essential to highlight.

1.2 - Symbols

The following symbols will appear within the warning triangles to alert the user to the specific type of danger or hazard.



Figure 1.2.1 – Different types of hazard and caution symbols

1.3 – Hazards



WARNING

Shock Hazard Potential

Severe injury or death from electrical shock may occur, if either user or the unit is wet, while the unit is connected to a power source. If the unit has come into contact with water, disconnect ac power from the ac source. If any of the Circuit Breakers have tripped due to water infiltration, DO NOT try to reset it with the ac line voltage attached. Follow standard procedures for resetting the DC Output Circuit Breaker under Section 3.5.



WARNING

Shock Hazard Potential

Severe injury or death from electrical shock can occur when damp electrical connections from the TI45014D Battery Charger/Conditioner are plugged into ac line voltage. See Section 6.1 for standard procedures in wet conditions.



CAUTION

Unit Damage Potential

Damage may occur if the TI45014D Battery Charger/Conditioner is operated after exposure to moisture (rain, fog, snow, etc.). If water infiltration is suspected, DO NOT CONNECT to ac voltage. Move the unit to a non-humid location and allow it to dry for a minimum of one (1) hour before operating again. DO NOT USE the unit if the exterior is damp. See Section 6.1 for standard procedures in wet conditions.



CAUTION

Unit Damage Potential

The use of unapproved ac power will damage the unit. Check the Input Voltage Selector Switch window to ensure the switch setting (115V or 230V) matches the ac power source prior to connecting the unit.

1.4 – Important Safety Precautions



WARNING

Fire/Explosion Hazard Potential

Severe injury or death from fire or explosion can occur if electrical sparks are produced near fuel vapors. Make sure the TI45014D Battery Charger/Conditioner is at least 20 feet (6 meters) away from the nearest fueling source before connecting either the ac or dc power cables.

Section 2 – Product Overview

2.1 – Introduction

Thank you and congratulations on the purchase of your new TI45014D Battery Charger/Conditioner.

This manual contains the complete operating instructions and procedures for the TI45014D Battery Charger/Conditioner. The TI45014D Battery Charger/Conditioner has been designed to rapidly recharge any 12 or 24 volt battery. This Battery Charger/Conditioner incorporates an intelligent recharging circuit that prevents overcharging and provides pure dc output for efficient battery charging and conditioning.

The TI45014D Battery Charger/Conditioner is encased in a rugged enclosure, and is designed to be used as a free standing unit, or to be mounted to a vehicle or other fixed object using the integrated mounting base. All models include a detachable ac line cord and an interchangeable dc output cable (alligator clamps for rapid connect and disconnect).

- Accepts both 120 Vac or 240 Vac and charges 12V and 24V batteries.

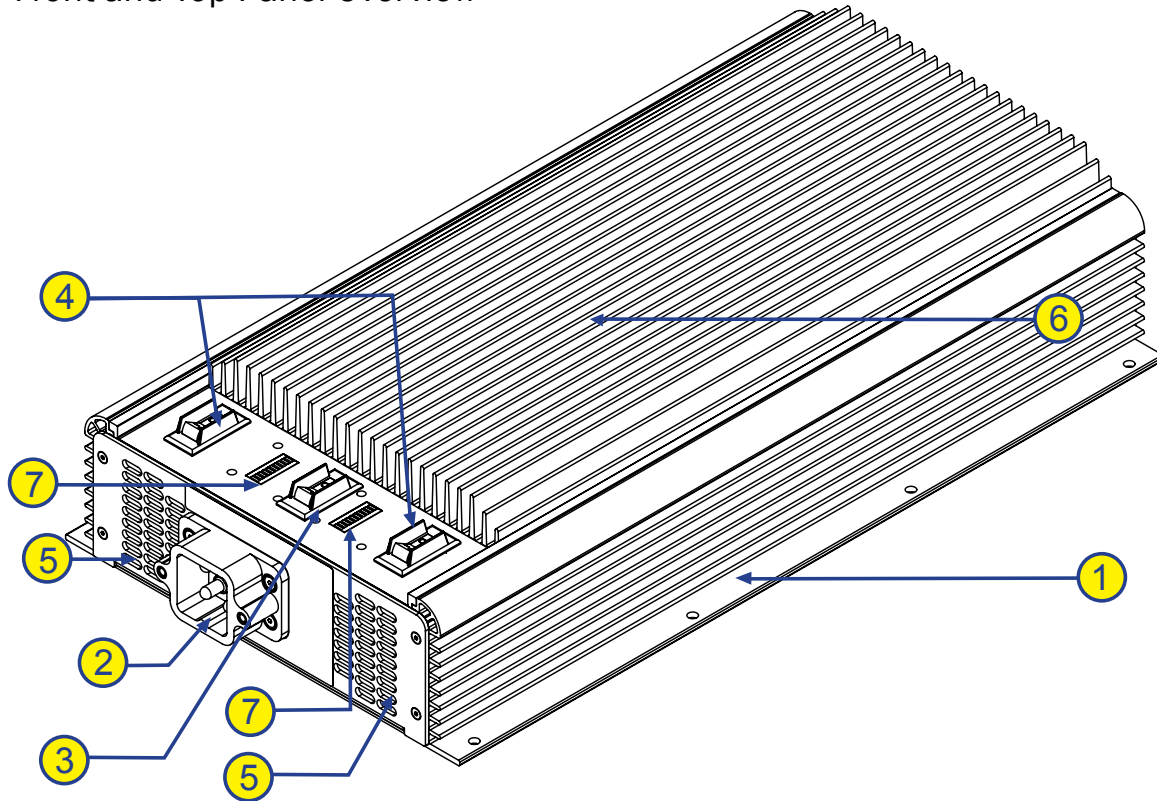

Figure 2.1.1 – TI45014D Battery Charger/Conditioner IEC

2.2 – Indication of Terms: Shall, Should, and May

Within this technical manual the word “shall” is used to indicate a mandatory requirement for proper operation and warranty purposes. The word “should” is used to indicate a non-mandatory but preferred method of accomplishment. The word “may” is used to indicate an acceptable method of accomplishment.

2.3 - Front and Top Panel Overview



- 1) **Mounting Base** – Allows mounting of the TI45014D Battery Charger/Conditioner via eight mounting holes.
- 2) **Main DC Output** – Provides 14.25 Vdc @ 80 amps max or 28.5 Vdc @ 40 amps max.
- 3) **AC Input Circuit Breaker** – Protects the internal electrical circuit from damage caused by overload or short circuit. Acts as an “On/Off” switch for the Battery Charger/Conditioner.
- 4) **DC Output Circuit Breakers** – Trips if an over-current condition occurs.
- 5) **Air Intake Ports** – Provides continuous airflow for cooling internal circuitry.
- 6) **Integrated Heatsink** – Provide additional heat dissipation under heavy loading conditions.
- 7) **Power Output Indicators** – Displays current battery charge level when connected to a battery.

2.4 – Rear Panel Overview

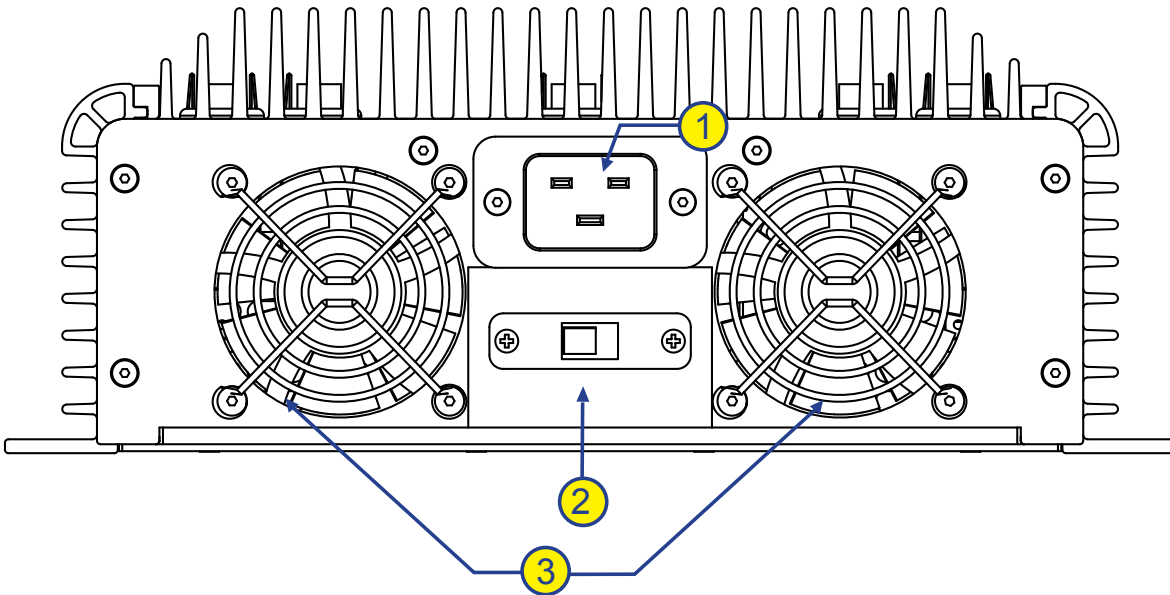

- 1) **AC Input Receptacle** – Connects to standard ac cable. Detachable ac line cord included.
- 2) **AC Input Voltage Selector Switch** – Allows manual selection of either 120 Vac or 240 Vac input voltage (see **Section 3.2** for proper selection).
- 3) **Cooling Fans** – Expel heated air drawn in by Air Intake Ports.

2.5 – Physical Dimensions

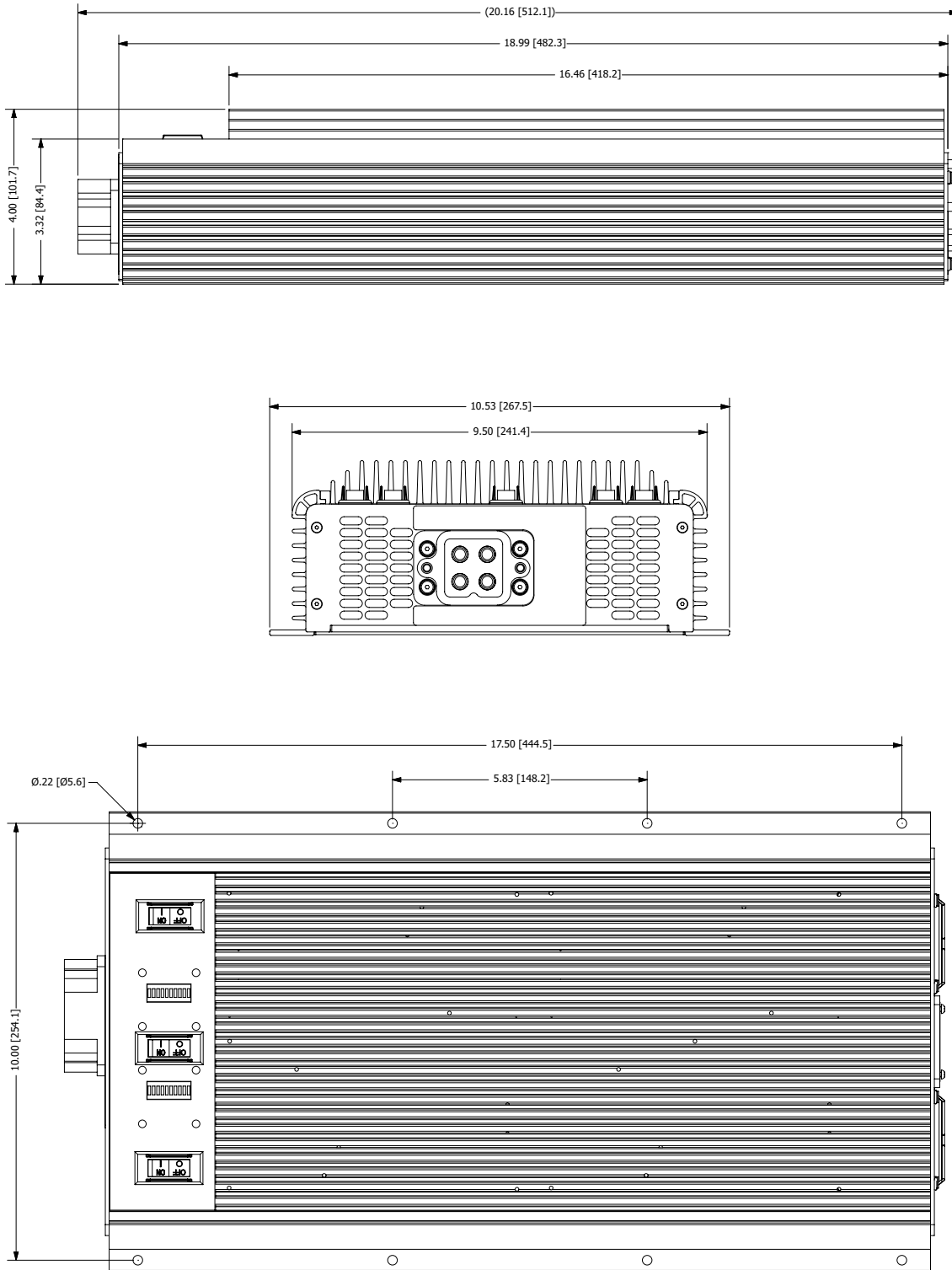

Measurements are in inches and millimeters
Figure 2.5.1 – TI45014D Battery Charger/Conditioner Physical Dimensions

2.6 – General Specifications

TI45014D Battery Charger/Conditioner:

Input:

- Operates from Single Phase 100-260 Vac / 40-500 Hz
- 1968 W (8.2 A rms @ 240 Vac)
- 1944 W (16.2 A rms @ 120 Vac)

Output:

- 1140 W (80 A continuous @ 14.25 Vdc) or (40 A continuous @ 28.5 Vdc)

Frequency

- 45-400 Hz

Temperature Ratings

- Operating temperature: -40°F to +60°F (-40°C to +140°C)
- Storage temperature: -65°F to +105°F (-85°C to +221°C)

Physical Specifications

- Dimensions: 19.98" L (507.6 mm) x 9.75" W (247.7 mm) x 4.63" H (117.5 mm)
- Weight: 17.45 lbs (7.92 kg)

2.7 – Airflow Ports

**CAUTION**

Damage may occur if the TI45014D's air intake or outlet ports are obstructed. Ensure that both ports are clear at all times

When the TI45014D Charger/Conditioner is plugged into ac power, the internal cooling system will efficiently regulate unit temperature regardless of load. At room temperature (+77 °F) the exhaust air will not exceed the ambient temperature by more than 5 °F. In more extreme temperatures (greater than 90 °F), the exhaust air will not exceed the ambient temperature by more than 10 °F.

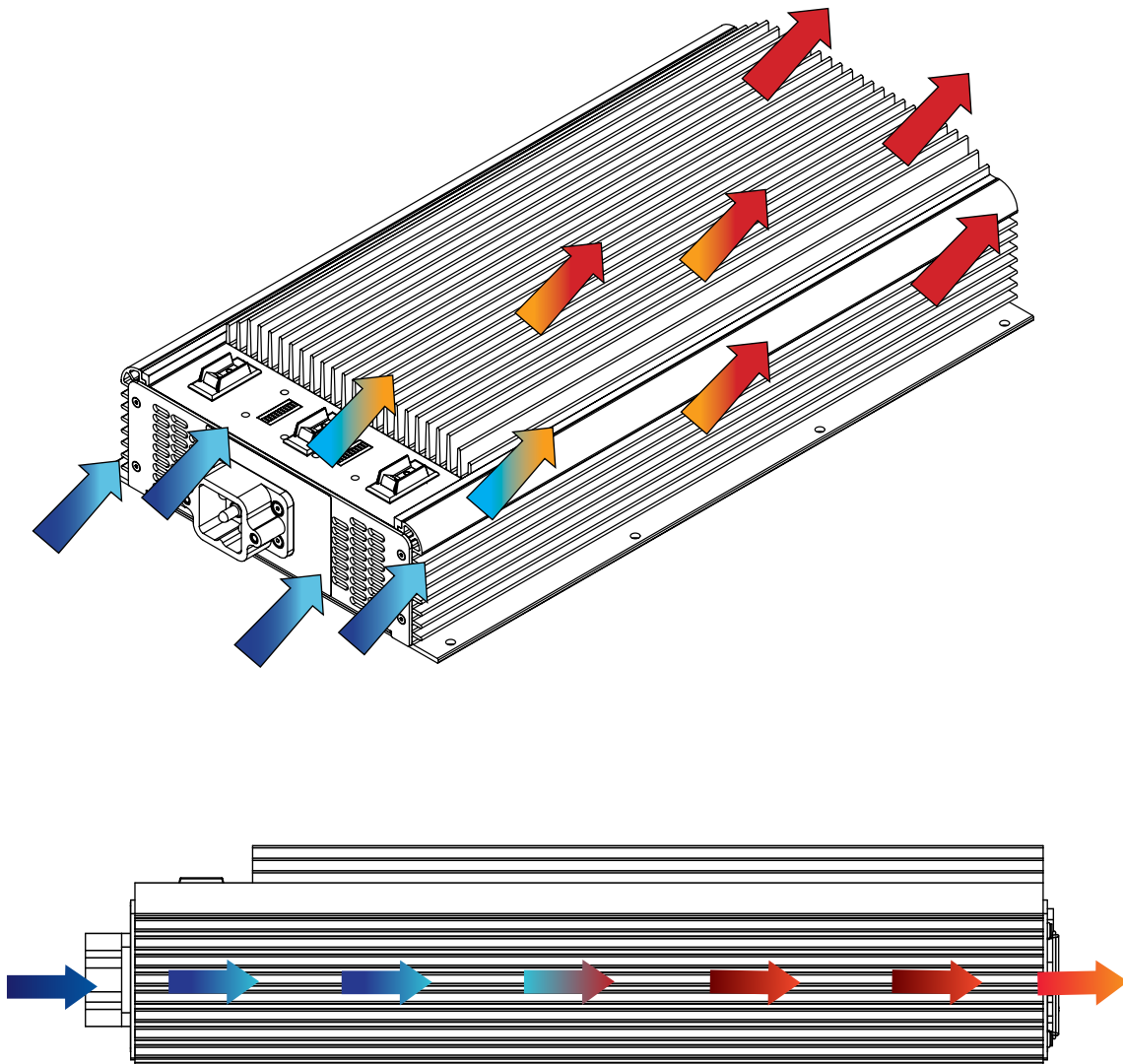

Figure 2.7.1 – Air intake and exhaust ports and the internal air circulation

Section 3 – Features Overview

3.1 – AC Input Receptacle



WARNING

Failure to use proper grounding can create a shock hazard.
Please refer to Section 4.2 for proper grounding techniques.

The TI45014D battery charger/conditioner comes with a quick disconnect ac receptacle (see Figure 3.1.1) and plugs into either a standard 120 or 240 Vac outlet with the supplied line cord (see Figure 3.1.2). See also Section 3.1a for the proper line cord for your country and region. Please ensure that the unit is properly grounded at all times.

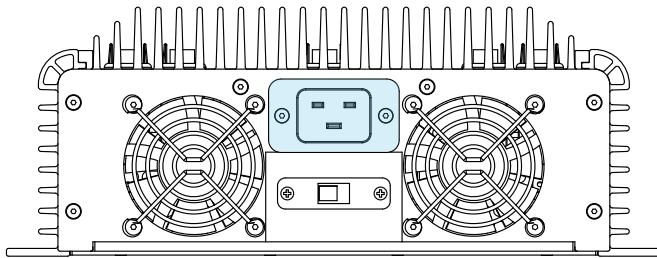

Figure 3.1.1 – AC Input Receptacle
(highlighted in blue)



Figure 3.1.2 – Connecting AC line cord

3.1a – IEC Line Cord Options

TI25000-053 North American Line Cord
TI25000-002 Italian Line Cord
TI25000-003 Continental European Line Cord
TI25000-004 Old British Line Cord
TI25000-005 England / UK Line Cord

TI25000-006 Swiss Line Cord
TI25000-011 Australian Line Cord
TI25000-200 Israel Line Cord
TI25000-300 Denmark Line Cord

3.2 – AC Input Selector Switch

The AC Input Voltage Selector Switch is located below the AC Input Receptacle on the rear panel (shown in Figure 3.2.1). This switch allows manual selection of either 120 (115) Vac or 240 (230) Vac input voltage. To change voltage input, simply follow these steps:

1. With cross tip screwdriver, remove one screw and rotate the clear protective cover to one side.
2. Flip the switch to desired position (115V or 230V).
3. Rotate cover back into place. Replace and tighten screw.

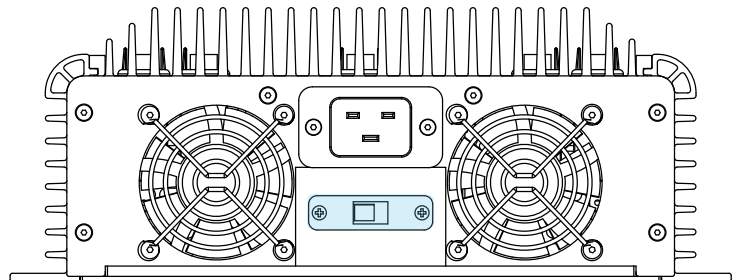

Figure 3.2.1 – AC Input Selector Switch
(highlighted in blue)

3.3 – AC Input Circuit Breaker

The AC Input Circuit Breaker located above the AC Input Receptacle (shown in Figure 3.3.1) protects the internal electrical circuit from damage caused by overload or short circuit. It also acts as an “On/Off” switch for the Battery Charger/Conditioner.

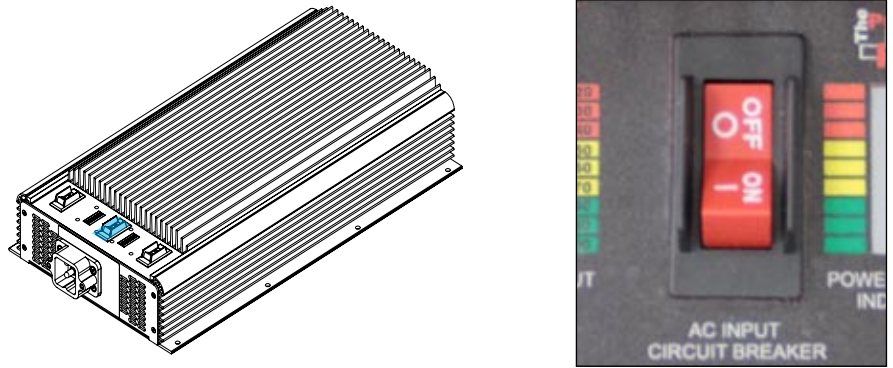

Figure 3.3.1 – AC Input Circuit Breaker
(highlighted in blue)

3.4 – DC Output Receptacle

The main DC Output Receptacle (shown in Figure 3.4.1) will provide either 14.25 Vdc or 28.5 Vdc. When properly connected, the TI45014D can deliver up to 80 amps at 14.25 Vdc or 40 amps at 28.5 Vdc. See Section 4.3 for proper connecting procedures.



Figure 3.4.1 – Main DC Output
(highlighted in blue)

3.5 – DC Output Circuit Breakers

The DC Output Circuit Breakers are located on the top panel of the TI45014D (See Figure 3.5.1). Each circuit breaker has an output of 40 amps. They can be used individually or combined together to output up to 80 amps or 40 amps. When the circuit breakers have been tripped, the button will pop up. In the event the breaker trips, verify that all connections are correct (polarity, line voltage, etc.) and reset the breaker by pushing the switch to the “ON” position. The unit should provide dc power automatically. If the breaker continues to trip, see Section 8 under Troubleshooting.

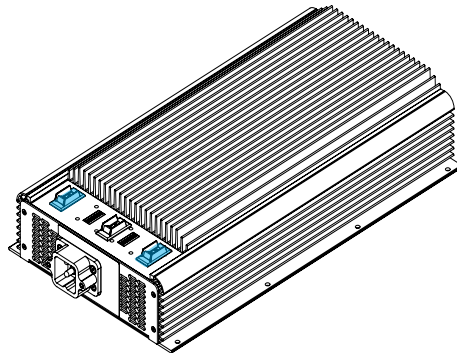

Figure 3.5.1 – DC Output Circuit Breaker
(highlighted in blue)

3.6 – Power Output Indicators

The Power Output Indicators are located on the top of the TI45014D (See Figure 3.6.1). When attached to a battery and ac line voltage, the Power Output Indicator shows the power cells’ charge state (See Figure 3.6.2). A full charge will be indicated by a single green bar next to the 100 on the indicator.

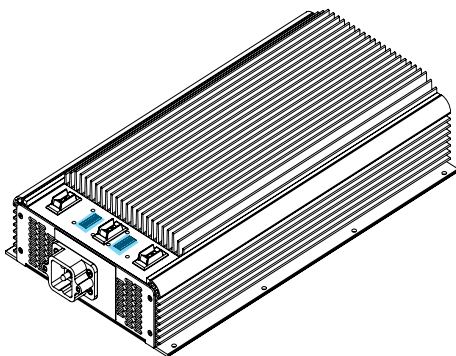

Figure 3.6.1 – Power Output Indicators
(highlighted in blue)

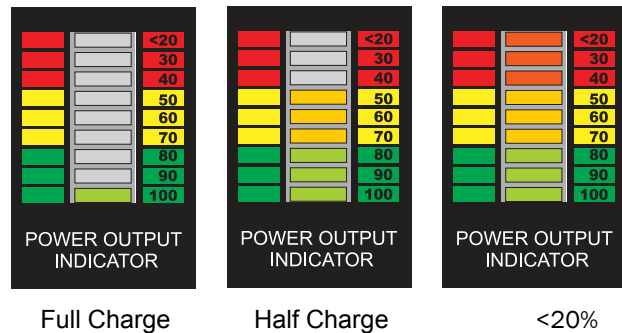

Figure 3.6.2 - Power Cells’ Charge State

3.7 – Integrated Heatsinks

In conjunction with the cooling system, the TI45014D is equipped with heatsinks (See Figure 3.7.1) on top and both sides of the unit to provide additional heat dissipation under full load conditions.

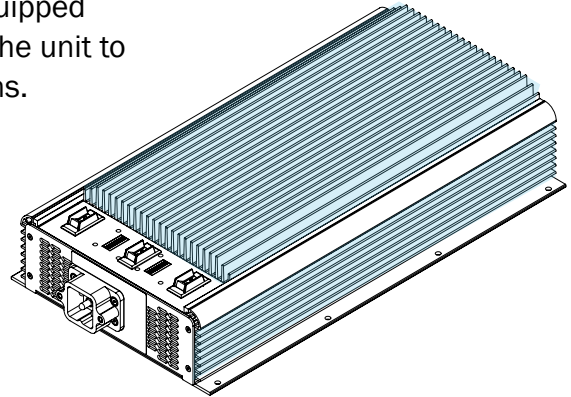
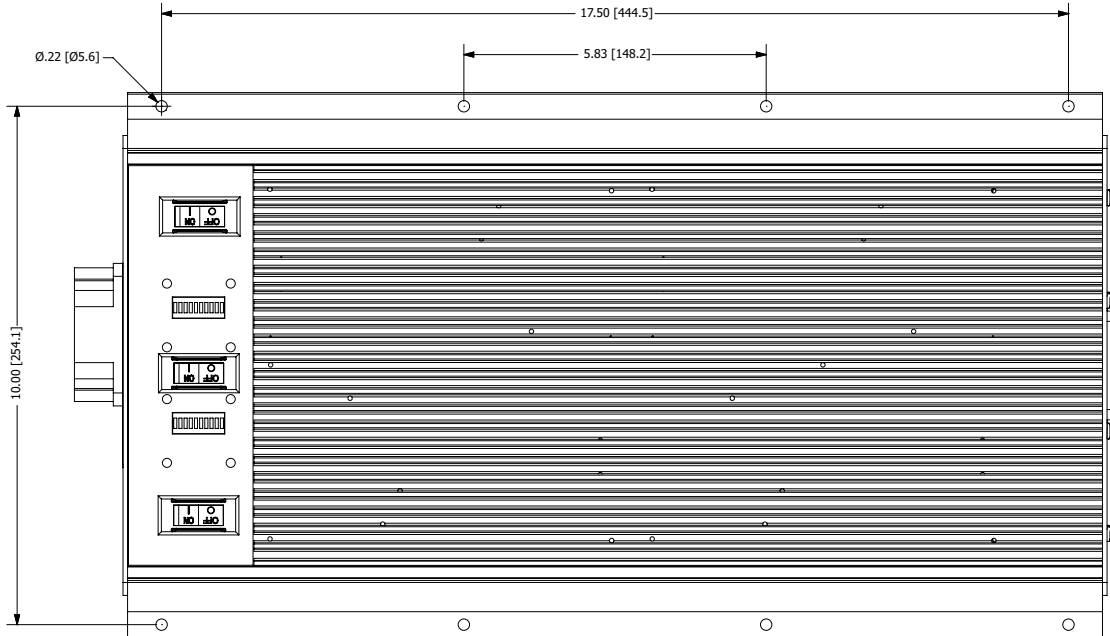

Figure 3.7.1 - Integrated Heat Sinks
(highlighted in blue)

3.8 – Mounting Base

The Mounting Base allows for easy mounting of the unit to any vehicle or other hard surface. Eight mounting holes have been strategically placed to properly secure the TI45014D. See Figure 3.8.1 for Mounting Base dimensions and hole locations.



Measurements are in inches and millimeters
Figure 3.8.1 – Mounting Base with Hole Locations

Section 4 – Pre-Operation Procedures

4.1 – Installing the Charger

The TI45014D Battery/Charger can be permanently integrated into vehicles and other equipment, or can be used as a free standing unit. Use the eight holes in the base of the unit to mount the unit. The holes are 0.213” (5.41 mm) and will accept up to 10-24 size bolts or M5 in metric. See Figure 3.8.1 in Section 3.8 for mounting hole dimensions. Once securely mounted to the vehicle or other equipment, proceed to the next step.

4.2 – Attaching AC Power

 CAUTION	Unit damage may occur if the wrong voltage is used. Make sure the line voltage is appropriate for your specific model.
--	--

 WARNING	Failure to use proper grounding can create a shock hazard. Please follow proper wiring procedures below.
--	--

Failure to use proper grounding can create a shock hazard. Depending on geographic location, the standard 220 Vac 50 Hz power cord may require a foreign plug adapter for compatibility. Use only adapters with a proper grounding mechanism.

Proper Ground



Proper Ground



Improper Ground



Figure 4.2.1- Illustrations of proper and improper grounding

Before plugging the TI45014D into ac power check the dc output cable to make sure the no two output wires are not touching (by disconnecting quick disconnect to prevent shorting).

4.3 – DC Power Cable Assemblies

The unit includes the TI2007-029 Dual Output Mini DC to Alligator Clamps 6 AWG, 6' Cable Assembly (shown in Figure 4.3.3). Depending on configuration (see page 18-19), if all four connectors are connected to same device, they can output up to 80 amps to battery. They can work in series or parallel. Refer to the pin-out configuration (see figure 4.3.1) for labeling of output cables.



Figure 4.3.1 DC Output Pin-Out Configuration

4.4 – Attaching the DC Power Cable

CAUTION

Unit damage may occur if the dc output cable is improperly wired. Make sure voltage is appropriate for your specific model.

1. Before wiring up the DC Output Cable, turn off all circuit breakers on the top of the unit, by pushing the rocker switch to the OFF position (outlined in yellow in figure 4.3.2).
2. Connect Dual Output Mini DC to Main DC Output (outlined in blue in figure 4.3.2)
3. Determine which configuration is suited for your use on pages 18-19.
4. Connect the alligator Clamps determined from configuration from your selection.
5. Check voltage selector switch (refer to Section 3.2).
6. Plug the ac line cord into the unit, then plug the ac line cord into a 120 or 240 power source.
7. Push the ac input circuit breaker rocker switch to the ON position.
8. Push both dc output circuit breaker rocker switches to the ON position.
9. Your TI45014D Battery Charger/Conditioner should now be charging and conditioning the battery.



Figure 4.3.2

WARNING

Do not hook up one set of alligator clamps and leave the other set loose. If the two clamps touch while charging, death or serious injury can occur. If using one alligator clamp, leave the Circuit Breaker OFF to the unused set.



Figure 4.3.3 – T12007-029 Dual Output Mini DC to Alligator Clamps

Red- Positive +
Black - Negative -



Figure 4.3.4 – Alligator Clamp Connectors and color coding

Section 5- Operating Procedures

5.1 – Before Operation

The TI45014D Battery Charger/Conditioner is engineered to provide continuous output power. The charger can be left connected to a battery until it is ready for use, because of the intelligent recharging system that prevents the TI45014D from overcharging the battery. Prior to connecting the TI45014D to an ac power source, be sure that the charger is at least 20 feet away from any fuel source to avoid a potential explosion due to sparking.

 WARNING	Make sure that the unit is at least 20 feet (6 meters) away from the nearest fueling source before connecting ac power.
--	---

5.2 – Connecting the Battery Charger

When you are ready to charge the battery in question, simply follow procedures below. The LED will show the battery's state of charge, and the cooling fan will start running after approximately one second. Let the battery fully recharge. The amount of time needed to charge the battery can be determined by dividing the amp hour rating of the battery by the output of the charger. For example, a 24 V battery with a 45 Ah rating using 24 Vdc TI45014D Battery Charger will take approximately 1 hour to charge. The TI45014D can be left connected to the battery past the charge time due to the intelligent recharge system and will continue to maintain and condition the battery while connected.

- 1. If the TI45014D Battery Charger is already connected to the battery and hard mounted to the vehicle:**
 - A. Plug the AC Line Cord into the appropriate ac source.
 - B. Check to see that the LED shows that status of the charge.
 - C. Check to see that the fan is running when the Battery Status LED is below 100%.

 CAUTION	Failure to follow these steps in order can cause arcing and or sparks.
--	--

- 2. If the TI45014D Battery Charger is not connected to the battery:**
 - A. Disconnect the DC Output Cable Assembly.
 - B. Attach the Alligator Clamps to the Battery. Positive connector first, then negative.
 - C. Plug in the AC Line Cord to the TI45014D (if disconnected).
 - D. Plug in the AC Line Cord to the appropriate AC source.
 - E. Connect the DC Output Cable Assembly.
 - F. Check to see that the LED shows that status of the charge.

5.3 – Disconnecting the Battery Charger

1. If the TI45014D Battery Charger is hard mounted to the vehicle:

- A. Disconnect the AC Line Cord from the AC Source.
- B. Disconnect the AC Line Cord from the Battery Charger.
- C. Stow the AC Line Cord for later use.

2. If the TI45014D Battery Charger is not hard mounted to the vehicle:

- A. Unplug the AC Line Cord from AC Source.
- B. Unplug the AC Line Cord from the TI450.
- C. Disconnect the Negative (Black) lead of the Alligator Clamp from the Battery.
- D. Disconnect the Positive (Red) lead of the Alligator Clamp from the Battery.
- E. Disconnect the DC Output cable.

5.4 – After Operation

Although the battery charger is ruggedized, good general care should be taken to maximize its life. Therefore, protect the unit from the elements and man-made hazards whenever possible. Do not expose to wet or dusty environments (rain, snow, sand, etc.) as this may damage internal circuitry. See Section 1.3 for more information concerning water infiltration.

5.5 – Configurations for 24V

In this setup, the two batteries are connected in SERIES. Connect the Negative(-) from Battery 1 to the Positive(+) terminal using a jumper wire or jumper bar. Connect Set A Positive(Red) to Positive terminal on Battery 1. Connect Set B Negative(black) to Negative(-) terminal on Battery 2. *Connect Set B Positive(Red) to Positive(-) terminal on Battery 2. Connect Set A Negative(Black) to Negative(-) terminal on Battery 1.

*Alternative configuration: The Negative(black) from Set A can also be connected or clamped together to the Positive(red) from Set B, as opposed to connecting the lines directly to the battery.

- 24V 40 amps to each battery

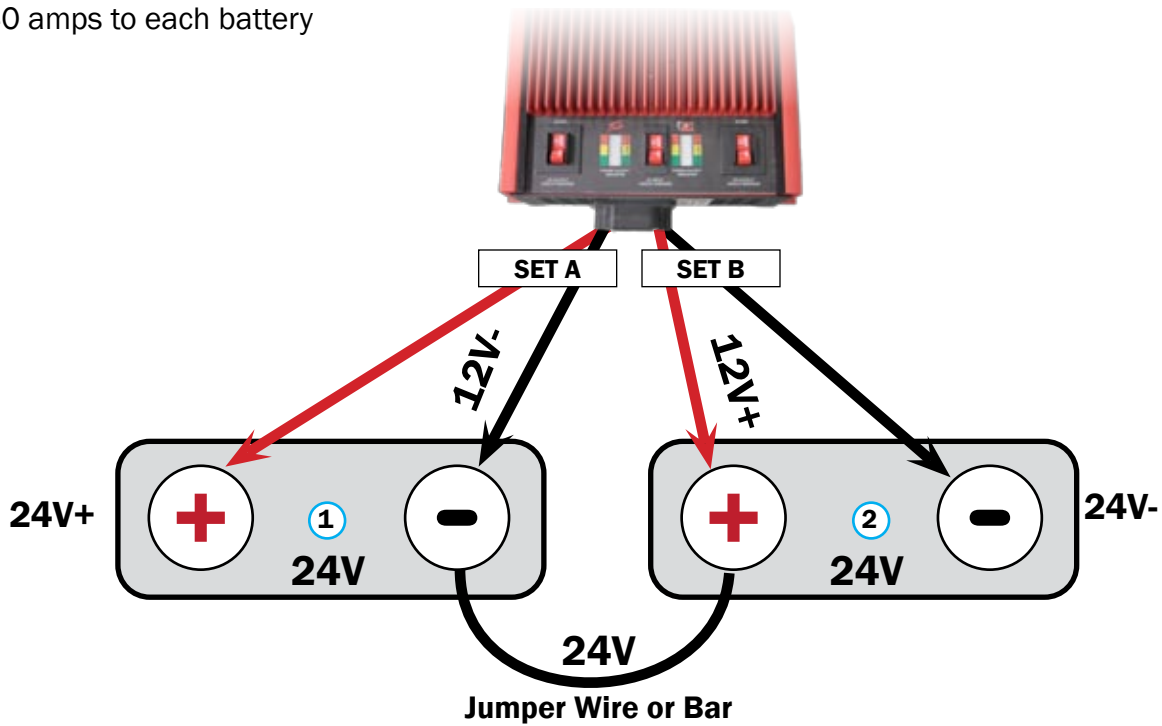

In this setup, one battery is connected in SERIES. The Negative (Black) from set A is connected or clamped to Positive (Red) from Set B. Set A Positive (Red) is connect to Positive(+) terminal. Set B Negative (Black) is connected to the Negative(-) terminal.

- 24V 40 amps to battery

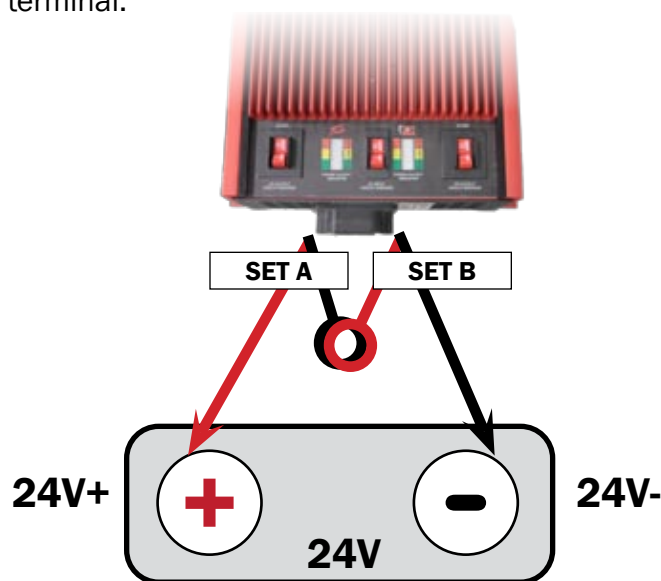

5.6 – Configurations for 12V

In this setup, two batteries are connected but are charging separate. Connect Positive(Red) from Set A to the Positive(+) terminal on Battery 1. Connect Negative(Black) from Set A to the Negative(-) terminals on Battery 1. Connect Positive(Red) from Set B to the Positive(+) terminals on Battery 2. Lastly, connect Negative(Black) from Set B to the Negative(-) terminal on Battery 2.

- 12V 40 amps to each battery

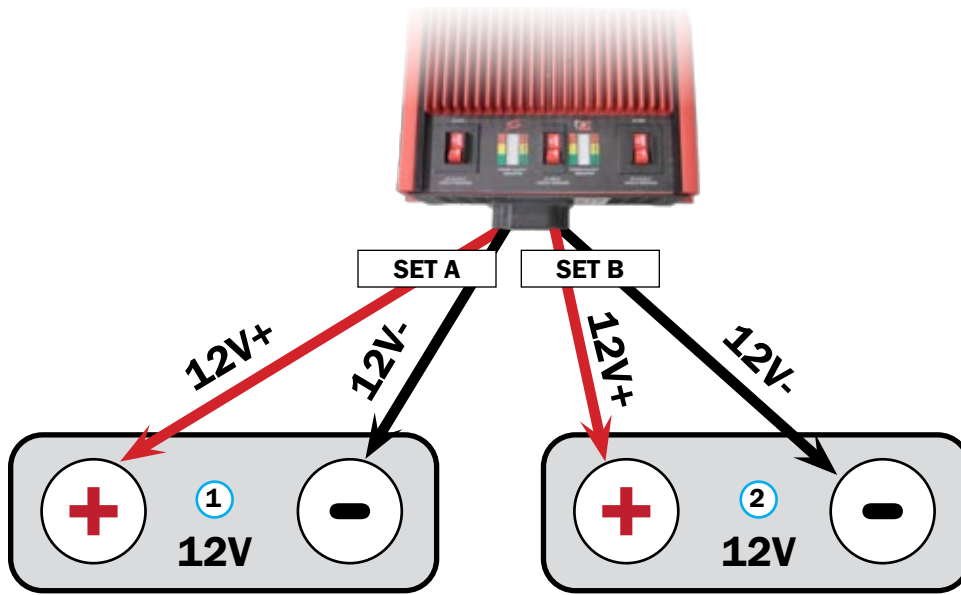

In this setup, one battery is connected in PARALLEL with the two sets of cords. Connect both Positive(Red) cords from Set A and B to the Positive(+) terminal of the battery. Then connect both Negative(black) cords from Set A and B to the Negative(-) terminal of the battery.

- 12V 80 amps to battery

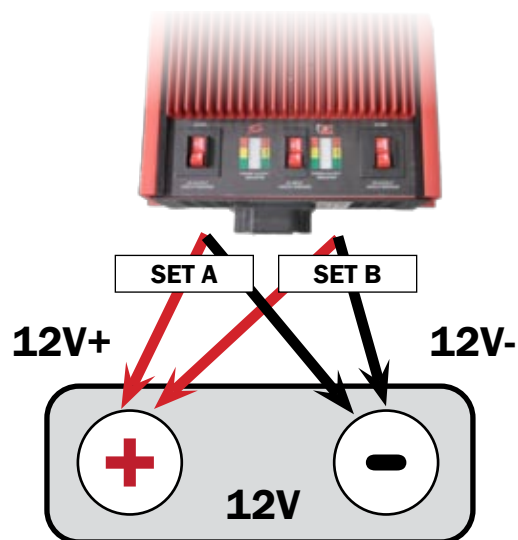

Section 6- Unit Care and Maintenance

6.1 – Unit Care

Avoid Prolonged Exposure to Extremely Damp Environments

Be sure to disconnect the TI45014D Battery Charger/Conditioner from ac power if it has come into contact with water. If the DC Output Circuit Breaker has tripped due to water infiltration, allow the unit to dry out before attempting to reset circuit breaker. Cover the unit to prevent water infiltration. If the unit is operated in extremely damp conditions, it should be stored in an environmentally controlled building when not in use.



	DANGER	Severe injury or death from electrical shock will occur if either the user or the TI45014D Battery Charger/Conditioner is wet while operating the unit with an ac power source attached.
--	---------------	---

Protect Cables from Damage

Do not cut, crush, or drag the input or output power cables when handling the TI45014D Battery Charger/Conditioner. Always inspect cables prior to use. If damage is evident (as shown in Figure 6.1.1), contact Tesla™ Customer Service. Do not attempt to use any other type of power cables other than the Tesla™ cables included with the TI45014D Battery Charger/Conditioner. Do not use the input or output cables as a carrying handle, damage to the cables and/or internal circuitry can occur.



Figure 6.1.1 – Damaged cable

TESLA™ INDUSTRIES, INCORPORATED
101 CENTERPOINT BLVD.
CENTERPOINT INDUSTRIAL PARK
NEW CASTLE, DELAWARE 19720
PHONE: (302) 324-8910 FAX: (302) 324-8912
WEBSITE: www.teslaind.com EMAIL: tesla1@teslaind.com

6.2 – Normal Function Test Procedure

This section concerns with “normal function” test procedures. It includes steps necessary to ensure that the TI45014D Battery Charger/Conditioner operates within specified parameters prior to use. A digital multimeter (an example is shown in Figure 6.2.1) capable of measuring dc voltage and resistance will be required to perform some of the tests. These functional test procedures should become routine.



Figure 6.2.1 - Digital Meter

Check Unit for Evidence of Damage

Check for dents, punctures, case distortion or misalignment, and cracked or loose connectors. If any damage is evident, contact the Tesla™ Customer Service.



WARNING

Severe injury or death from electrical shock can occur. Ensure that both the ac input cable and dc output cable are disconnected before performing any tests.

Checking Unit Internal Resistance (Testing for Shorts)

It is essential to test for shorts to detect any problems with the unit. To do so, you will need to set your multimeter to measure Ω or “resistance.” You can test to see if both the ac input and dc output terminals are isolated from the case and line ground in the following steps.

- Step 1** Place the negative probe (black) of the multimeter on the ac plug ground pin and the positive probe (red) on one of the screws of the ac input (figure 6.2.2)
> The multimeter should read nearly 0 Ω .
- Step 2** Move the positive probe to one of the two ac plug blades.
> The multimeter should now read greater than 1 M Ω .
- Step 3** Move the positive probe to the other ac plug blade.
> The multimeter should again read greater than 1 M Ω .
- Step 4** Next, move the positive probe to the dc output cable black alligator clamp.
> The multimeter should read greater than 1 M Ω .
- Step 5** Finally, move the positive probe to the dc output cable red alligator clamp.
> The multimeter should read greater than 1 M Ω .



Figure 6.2.2 - AC Input

If the following multimeter measurements correspond to the above steps, the unit has no internal shorts.

Checking DC Voltage at the DC Output Cable

In order to properly test the dc output the unit needs to be connected to a battery. Make sure to reconnect the DC Output Cable according to Section 5 Pre-Operation procedures. Then, plug the unit into the appropriate line voltage. Once accomplished, set your digital multimeter to measure dc voltage. Place the positive probe (red) of the multimeter on the positive clamp (red) of the DC Output Cable. Next, place the negative probe (black) on the negative clamp (black) of the DC Output Cable. The multimeter display should read between $14.240 \pm 50\text{mV}$ for the TI45014D charger. If the unit is not providing any output voltage refer to Section 8 under Troubleshooting. Otherwise, contact the Tesla™ Customer Service at (302) 324-8910.

Once the TI45014D Battery Charger/Conditioner has fully passed function test procedures, the unit is ready for use.

6.3 – Unit Servicing

The TI45014D Battery Charger/Conditioner is a maintenance-free, sealed unit. No repairs outside of Tesla™ are authorized. Warranty will be voided if unit is tampered with in any way including any damage to the WARRANTY VOID stickers located on the case (see Figure 6.3.1 below). If the unit requires service, please contact Tesla™ Customer Service at (302) 324-8910. A Repair Request Form can be found on the last page of this manual or online at www.teslaind.com.



Figure 6.3.1 – Warranty Void Sticker

6.4 – Packaging and Shipping

When shipping the TI45014D Battery Charger/Conditioner for service, please ensure proper packaging. Pack the unit in a box with at least 2-3 inches of clearance on all sides (be sure to enclose the Repair Request Form). To guarantee that the unit remains centered within the box, do not use loose packing materials such as packing peanuts. Instead, wrap the unit tightly in foam or other dense material until it fits snugly in the box. Seal the box on all sides and return it to Tesla™. Please contact Tesla™ Customer Service at (302) 324-8910 with any questions or concerns.

Section 7 – Frequently Asked Questions

1. How does a Tesla™ TI45014D Battery Charger/Conditioner work?

The Tesla™ TI45014D Battery Charger/Conditioner incorporates an intelligent charging system with a pure dc output that allows it to rapidly charge and condition a battery without overcharging or damaging it.

2. How much DC power will the TI45014D Battery Charger/Conditioner provide?

The TI45014D Battery Charger/Conditioner will provide up to 80 continuous amps @ 14.25 Vdc or 40 continuous amps @ 28.5 Vdc depending on if they are set up in series or parallel.

2. How long will it take to charge my battery?

Battery charge time can be determined by taking the battery's rated amp hours and dividing this number by the TI45014D's maximum output current. For example, a 12 V / 20 Ah battery will take one hour to charge using a TI45014 series Battery Charger/Conditioner.

3. What is included with my TI45014D Battery Charger/Conditioner?

The Battery Charger/Conditioner comes with a Tesla™ approved ac input power cable (TI25000-211 NEMA North American Line Cord), a dc output power cable with a color coded alligator clamp cable assembly (TI2007-029 Dual Output Mini DC to Alligator Clamps 6AWG, 6' Cable Assembly), a user manual, and a limited two-year warranty.

4. Is the TI45014D Battery Charger/Conditioner waterproof?

The TI45014D Battery Charger/Conditioner is NOT waterproof. See Section 1.3 under Water Hazards for further information regarding safe operation in damp environments.

5. Are there any HAZMAT or disposal issues?

No. Contact Tesla™ for more information.

Section 8 – Troubleshooting

1. When I connect the TI45014D Battery Charger/Conditioner to ac power my battery does not charge.

While charging, the Charge Level Indicator should be illuminated. If this LED is not lit follow the procedure listed below.

Is there AC line voltage at the Outlet?

No: Consult an electrician. Yes: Contact Tesla™ Industries.

2. The Charge Level Indicator is illuminated, but my battery still does not charge.

The Charge Level Indicator illuminates when there is voltage present at the DC Output. The DC Output Circuit Breaker controls voltage going out to the DC Output Cable.

Is the DC Output Circuit Breaker tripped (see Section 4.4)?

No: Proceed to next step. Yes: Reset the breaker.

With the Battery Charger plugged into ac line voltage, check the dc output with a multimeter on the dc output terminals (See Section 6.2 under Checking DC Voltage for proper testing procedures).

Does the DC Output show the proper voltage?

No: Contact Tesla™ Industries. Yes: Replace your battery

3. When I apply ac power to the Battery Charger, the Cooling Fan does not turn on.

The Cooling Fan inside the TI45014D Battery Charger/Conditioner is designed to run only when a load is applied. It will tick when no load is present. If the fan is not on when the Battery Charger is under load, this may indicate that the Cooling Fan has failed. Disconnect power immediately and contact Tesla™ for further instructions.

4. Can I make repairs to the unit?

No. The TI45014D Battery Charger/Conditioner is a maintenance-free, sealed unit. No repairs outside of Tesla™ are authorized. Warranty will be voided if unit is tampered with in any way, including any damage to the WARRANTY VOID stickers located on the case.

5. How do I get my TI45014D Battery Charger/Conditioner serviced?

If the unit needs to be serviced, please contact Tesla™ Customer Service by phone at (302) 324-8910 or by email at tesla1@teslaind.com, and a representative will explain the return process. For your convenience, a Repair Request Form can be found on the last page of this manual. The form can also be found online at www.teslaind.com.

6. What type of special maintenance does the TI45014D Battery Charger/ Conditioner require?

Keep the unit in a well ventilated, climate-controlled environment while charging. Always keep the vent areas clean and free of debris. See Section 1.3 regarding Water Hazards and Section 6 under Unit Care.

Section 9- Performance Data

9.1 – Purpose

This chapter provides performance data for the TI45014D Battery Charger/Conditioner. This information will allow the user to obtain maximum performance and life from the unit. Regular referral to this chapter is recommended to:

- A) Gain knowledge of the unit's performance characteristics to anticipate unexpected conditions or extreme operational requirements.
- B) Readily identify situations requiring maximum performance.

Note: *The information provided in this chapter is most useful when anticipating operations under unknown conditions or environmental extremes. The data can also be used to establish local operating procedures and to maximize the unit's life.*

9.2 – Explanation of Data

The data presented covers the full range of operating conditions and expected performance. In each area of performance, temperature effects and dc electrical load demands in relation to ground power support requirements are presented. In some cases, data is presented conservatively. In all cases, performance data presented is within the applicable limits of the TI45014D Battery Charger/Conditioner. Any attempt to exceed maximum recommended limits will cause the unit to malfunction and may cause permanent damage.

9.3 – Definition of Abbreviations

Unless otherwise indicated, the abbreviations defined before page 1 will be applicable to all charts and graphs in this chapter.

9.4 – Performance Graph

Approximate charging time @ 25 °C needed to fully recharge battery.

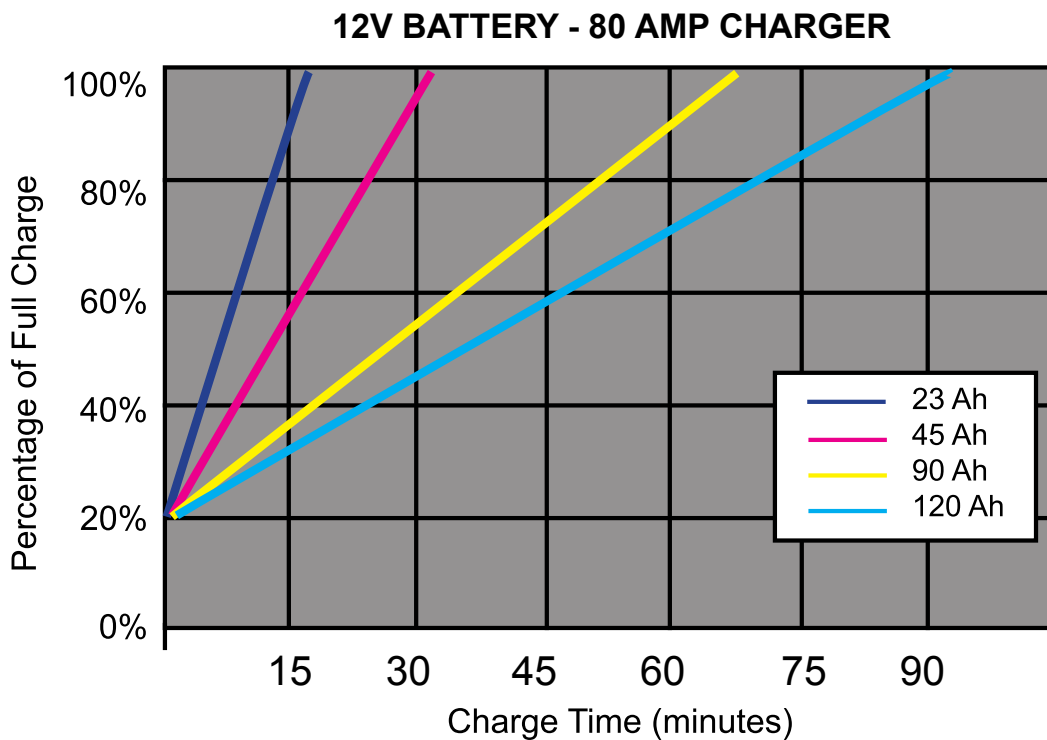
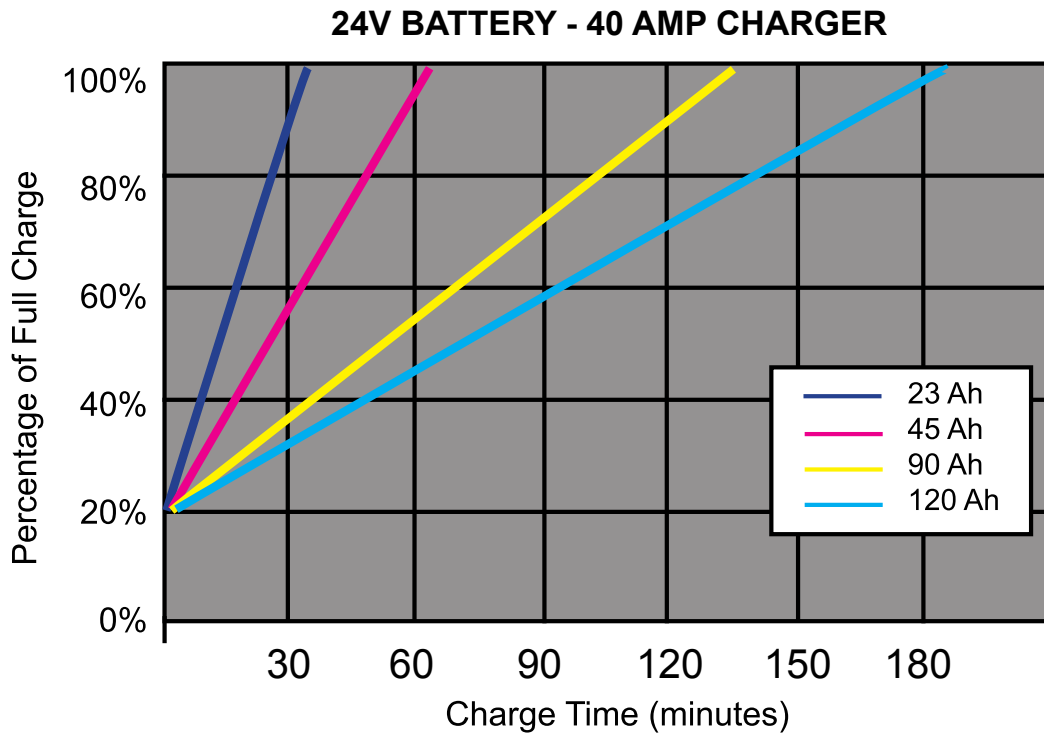

9.5 - Temperature Conversion Chart

°C	°F	°C	°F	°C	°F	°C	°F
-60.0	-76.0	-27.0	-16.6	6.0	42.8	39.0	102.2
-59.0	-74.2	-26.0	-14.8	7.0	44.6	40.0	104.0
-58.0	-72.4	-25.0	-13.0	8.0	46.4	41.0	105.8
-57.0	-70.6	-24.0	-11.2	9.0	48.2	42.0	107.6
-56.0	-68.8	-23.0	-9.4	10.0	50.0	43.0	109.4
-55.0	-67.0	-22.0	-7.6	11.0	51.8	44.0	111.2
-54.0	-65.2	-21.0	-5.8	12.0	53.6	45.0	113.0
-53.0	-63.4	-20.0	-4.0	13.0	55.4	46.0	114.8
-52.0	-61.6	-19.0	-2.2	14.0	57.2	47.0	116.6
-51.0	-59.8	-18.0	-0.4	15.0	59.0	48.0	118.4
-50.0	-58.0	-17.0	1.4	16.0	60.8	49.0	120.2
-49.0	-56.2	-16.0	3.2	17.0	62.6	50.0	122.0
-48.0	-54.4	-15.0	5.0	18.0	64.4	51.0	123.8
-47.0	-52.6	-14.0	6.8	19.0	66.2	52.0	125.6
-46.0	-50.8	-13.0	8.6	20.0	68.0	53.0	127.4
-45.0	-49.0	-12.0	10.4	21.0	69.8	54.0	129.2
-44.0	-47.2	-11.0	12.2	22.0	71.6	55.0	131.0
-43.0	-45.4	-10.0	14.0	23.0	73.4	56.0	132.8
-42.0	-43.6	-9.0	15.8	24.0	75.2	57.0	134.6
-41.0	-41.8	-8.0	17.6	25.0	77.0	58.0	136.4
-40.0	-40.0	-7.0	19.4	26.0	78.8	59.0	138.2
-39.0	-38.2	-6.0	21.2	27.0	80.6	60.0	140.0
-38.0	-36.4	-5.0	23.0	28.0	82.4	61.0	141.8
-37.0	-34.6	-4.0	24.8	29.0	84.2	62.0	143.6
-36.0	-32.8	-3.0	26.6	30.0	86.0	63.0	145.4
-35.0	-31.0	-2.0	28.4	31.0	87.8	64.0	147.2
-34.0	-29.2	-1.0	30.2	32.0	89.6	65.0	149.0
-33.0	-27.4	0.0	32.0	33.0	91.4	66.0	150.8
-32.0	-25.6	1.0	33.8	34.0	93.2	67.0	152.6
-31.0	-23.8	2.0	35.6	35.0	95.0	68.0	154.4
-30.0	-22.0	3.0	37.4	36.0	96.8	69.0	156.2
-29.0	-20.2	4.0	39.2	37.0	98.6	70.0	158.0
-28.0	-18.4	5.0	41.0	38.0	100.4	71.0	159.8

Figure 9.5.1 – Temperature conversion from Celsius to Fahrenheit

Glossary

Amp-Hour (Ah)	The technical term for how much electrical charge a particular battery will hold. This number can also be used to determine charge and discharge rates.
Digital Multimeter	A digital multimeter, also known as a volt/ohm meter or VOM, is an electronic measurement device that combines several functions into one unit. A standard multimeter may include features such as the ability to measure voltage, current and resistance.
Intelligent Recharging	A system which continuously monitors the cell's charge state and automatically adjusts the recharge rate to maximum performance and minimize cell degradation.
Lead Acid Battery	A battery that uses the reaction of lead and lead oxide with sulfuric acid electrolytes to produce a voltage (e.g. a car battery).
Memory Effect	If a NiCd battery is only partially discharged and then recharged many times, it will begin to "remember" the level at which it was discharged and will no longer fully recharge. Lead Acid Batteries do not suffer from memory effect.
Monolithic Dry-Cell	A one-piece battery that is hermetically sealed and designed for maintenance-free operation.
NiCd Battery	The NiCd, or nickel-cadmium battery, is a type of rechargeable battery that uses nickelic hydroxide and cadmium as electrodes (e.g. rechargeable power tools).

Section 10 - Optional Accessories

10.1 – TI2007-070 Mini-DC to Aviation Cable Assembly

The Tesla™ TI2007-070 Mini-DC to Aviation makes it possible to charge and condition aviation batteries with the Tesla™ TI45014D Battery Charger/Conditioner.

DC output result from TI45014D Battery Charger/Conditioner using TI2007-070 is 40 amps continuous @ 28.5 Vdc to charge and condition aviation batteries.



*4 AWG, 25' Cable Assembly

10.2 – TI2007-071 Mini-DC to Compact NATO Cable Assembly

The Tesla™ TI2007-071 Mini-DC to Compact NATO makes it possible to charge and condition 24 Volt vehicle batteries with the Tesla™ TI45014D Battery Charger/Conditioner.

DC output result from TI45014D Battery Charger/Conditioner using TI2007-071 is 40 amps continuous @ 28.5 Vdc to charge and condition vehicle's batteries.



*4 AWG, 25' Cable Assembly

Repair Request Form

Please complete the information below to ensure prompt and accurate service. Include this form with the unit you are returning. Thank you.

Date of return: _____

Company name & _____

Billing address: _____

Contact person: _____

Phone #: _____ Fax #: _____

Email: _____

Purchase Order #: _____

Model #: _____ Serial #: _____

Model #: _____ Serial #: _____

Shipping method to Tesla™: _____

Description of shipping package: _____

Description of problem: _____

Return to Tesla™

101 Centerpoint Boulevard, New Castle, DE 19720 Attention: Repair Department



WE GET THE MILITARY STARTED!

Tesla™

101 Centerpoint Blvd.
New Castle, DE 19720 USA
Tel: 302-324-8910
Fax: 302-324-8912

9475 Double R Blvd., Suite 2
Reno, NV 89521
Tel: 775-622-8801
Fax: 775-622-8810

www.teslaind.com ♦ www.tesla1.com