



Power Anytime, Anywhere

# Tesla™ TI4200 GPU-24-PFC

## User Manual



*Built Smart...Proven Tough*

**Tesla Industries, Inc.**  
101 Centerpoint Blvd.  
New Castle, DE 19720  
(302) 324-8910 Phone  
(302) 324-8912 Fax  
[www.teslaind.com](http://www.teslaind.com)  
[www.tesla1.com](http://www.tesla1.com)

# NOTE: All users must read this entire manual prior to operating the TI4200 GPU-24-PFC.

The TI4200 GPU-24-PFC is a limited maintenance-free and sealed unit. No repairs are authorized. Warranty will be voided if unit is tampered with in any way, or if unauthorized repairs are made. For technical support please contact:

TESLA™ INDUSTRIES INCORPORATED  
101 CENTERPOINT BLVD.  
CENTERPOINT INDUSTRIAL PARK, NEW CASTLE, DELAWARE 19720  
PHONE: (302) 324-8910 FAX: (302) 324-8912  
WEBSITE: [www.teslaind.com](http://www.teslaind.com) ♦ [www.tesla1.com](http://www.tesla1.com) EMAIL: [tesla1@teslaind.com](mailto:tesla1@teslaind.com)



Improper use or failure to follow instructions in this user manual can result in unit damage and/or injury or death by electrical shock.

Any attempts to open or examine the inside of the unit via a tool or device (borescope, probe, etc.) can result in unit failure and/or injury by electrical shock. This GPU is maintenance free and should not be opened or disassembled for any reason.

Always protect the unit from short circuit.

Shipping Hazards: The unit contains sealed, dry cell rechargeable batteries that do not pose a shipping hazard.

All Ground Power Units, Micro Power Units (Aviation Batteries) and including, but not limited to, Battery Chargers/Conditioners, manufactured by Tesla™ Industries, Inc., are able to safely and effectively charge any AGM, Lead Acid battery.

The Tesla™ GPU's and chargers are voltage and current regulated to 0.01% (dual loop). The charging voltage is calibrated, by Tesla™, to 28.6 volts and is pure dc (no power line ripple).

### Maximum Charge Voltage by Battery Type

| Type:             | Charging Voltage / Cell | Charging Voltage / 12v | Charging Voltage / 24v |
|-------------------|-------------------------|------------------------|------------------------|
| SLI/Flooded       | 2.366v to 2.416v        | 14.2v to 14.5v         | 28.4v to 29v           |
| Lead Acid/Flooded | 2.366v to 2.416v        | 14.2v to 14.5v         | 28.4v to 29v           |
| Sealed Lead Acid  | 2.366v to 2.416v        | 14.2v to 14.5v         | 28.4v to 29v           |
| VRLA              | 2.366v to 2.416v        | 14.2v to 14.5v         | 28.4v to 29v           |
| AGM               | 2.433v to 2.466v        | 14.6v to 14.8v         | 29.2v to 29.6v         |
| GEL               | 2.350v to 2.400v        | 14.1v to 14.4v         | 28.2v to 28.8v         |

Copyright © 2020 by Tesla™ Industries, Incorporated. All rights reserved.



**SAFETY DATA SHEET**

Form #: SDS 853027  
 Revised: AG  
 Supersedes: AF  
 ECO #: 1002195

|                                                                                                                     |                                                                                                                      |
|---------------------------------------------------------------------------------------------------------------------|----------------------------------------------------------------------------------------------------------------------|
| <b>I. PRODUCT IDENTIFICATION</b>                                                                                    |                                                                                                                      |
| <b>Chemical Trade Name (as used on label):</b><br>Tesla™ Industries, Inc.                                           | <b>Chemical Family/Classification:</b><br>Sealed Lead Battery                                                        |
| <b>Synonyms:</b><br>Sealed Lead Acid Battery, VRLA Battery                                                          | <b>Telephone:</b><br>For information, contact Tesla™ Industries, Inc.<br>Customer Service Department at 302-324-8910 |
| <b>Manufacturer's Name/Address:</b><br>Tesla™ Industries, Inc<br>101 Centerpoint Blvd.<br>New Castle, DE 19720-4180 | <b>24-Hour Emergency Response Contact:</b><br>CHEMTREC DOMESTIC: 800-424-9300 CHEMTREC INT'L: 703-527-3877           |

|                                                                                                                                                                                                                                                                                                              |                                      |                                  |
|--------------------------------------------------------------------------------------------------------------------------------------------------------------------------------------------------------------------------------------------------------------------------------------------------------------|--------------------------------------|----------------------------------|
| <b>II GHS HAZARDS IDENTIFICATION</b>                                                                                                                                                                                                                                                                         |                                      |                                  |
| <b>HEALTH</b>                                                                                                                                                                                                                                                                                                | <b>ENVIRONMENTAL</b>                 | <b>PHYSICAL</b>                  |
| Acute Toxicity (Oral/Dermal/Inhalation) Category 4<br>Skin Corrosion/Irritation Category 1A<br>Eye Damage Category 1<br>Reproductive Category 1A<br>Carcinogenicity (lead compounds) Category 1B<br>Carcinogenicity (acid mist) Category 1A<br>Specific Target Organ Toxicity (repeated exposure) Category 2 | Aquatic Chronic 1<br>Aquatic Acute 1 | Explosive Chemical, Division 1.3 |

|                   |                      |                 |
|-------------------|----------------------|-----------------|
| <b>GHS LABEL:</b> |                      |                 |
| <b>HEALTH</b>     | <b>ENVIRONMENTAL</b> | <b>PHYSICAL</b> |
|                   |                      |                 |

|                                                                                                                                                                                                                                                                                                                                                                                                                                                                                                                                                                             |                                                                                                                                                                                                                                                                                                                                                                                                                                                                                                                                                                                                                                                                                                                             |
|-----------------------------------------------------------------------------------------------------------------------------------------------------------------------------------------------------------------------------------------------------------------------------------------------------------------------------------------------------------------------------------------------------------------------------------------------------------------------------------------------------------------------------------------------------------------------------|-----------------------------------------------------------------------------------------------------------------------------------------------------------------------------------------------------------------------------------------------------------------------------------------------------------------------------------------------------------------------------------------------------------------------------------------------------------------------------------------------------------------------------------------------------------------------------------------------------------------------------------------------------------------------------------------------------------------------------|
| <b>Hazard Statements</b><br><b>DANGER!</b><br>Causes severe skin burns and serious eye damage.<br>May damage fertility or the unborn child if ingested or inhaled.<br>May cause cancer if ingested or inhaled.<br>Causes damage to central nervous system, blood and kidneys through prolonged or repeated exposure.<br>May form explosive air/gas mixture during charging.<br>Explosive, fire, blast, or projection hazard.<br>May cause harm to breast-fed children<br>Harmful if swallowed, inhaled, or contact with skin<br>Causes skin irritation, serious eye damage. | <b>Precautionary Statements</b><br>Wash thoroughly after handling.<br>Do not eat, drink or smoke when using this product.<br>Wear protective gloves/protective clothing, eye protection/face protection.<br>Avoid breathing dust/fume/gas/mist/vapors/spray.<br>Use only outdoors or in a well-ventilated area.<br>Contact with internal components may cause irritation or severe burns. Avoid contact with internal acid.<br>Irritating to eyes, respiratory system, and skin.<br>Obtain special instructions before use.<br>Do not handle until all safety precautions have been read and understood<br>Avoid contact during pregnancy/while nursing<br>Keep away from heat./sparks/open flames/hot surfaces. No smoking |
|-----------------------------------------------------------------------------------------------------------------------------------------------------------------------------------------------------------------------------------------------------------------------------------------------------------------------------------------------------------------------------------------------------------------------------------------------------------------------------------------------------------------------------------------------------------------------------|-----------------------------------------------------------------------------------------------------------------------------------------------------------------------------------------------------------------------------------------------------------------------------------------------------------------------------------------------------------------------------------------------------------------------------------------------------------------------------------------------------------------------------------------------------------------------------------------------------------------------------------------------------------------------------------------------------------------------------|

|                                                        |                   |                                |
|--------------------------------------------------------|-------------------|--------------------------------|
| <b>III. COMPOSITION/INFORMATION ON INGREDIENTS</b>     |                   |                                |
| <b>Components</b>                                      | <b>CAS Number</b> | <b>Approximate % by Weight</b> |
| <b>Inorganic Lead Compound:</b>                        |                   |                                |
| Lead                                                   | 7439-92-1         | 45 - 60                        |
| Lead Dioxide                                           | 1309-60-0         | 15 - 25                        |
| Tin                                                    | 7440-31-5         | 0.1 - 0.2                      |
| <b>Sulfuric Acid Electrolyte (Sulfuric Acid/Water)</b> | 7664-93-9         | 15 - 20                        |
| <b>Case Material:</b>                                  |                   | 5 - 10                         |
| Polypropylene                                          | 9003-07-0         |                                |
| Polystyrene                                            | 9003-53-6         |                                |
| Styrene Acrylonitrile                                  | 9003-54-7         |                                |
| Acrylonitrile Butadiene Styrene                        | 9003-56-9         |                                |
| Styrene Butadiene                                      | 9003-55-8         |                                |
| Polyvinylchloride                                      | 9002-86-2         |                                |
| Polycarbonate, Hard Rubber, Polyethylene               | 9002-88-4         |                                |
| Polyphenylene Oxide                                    | 25134-01-4        |                                |
| Polycarbonate/Polyester Alloy                          | --                |                                |
| <b>Other:</b>                                          |                   |                                |
| Absorbent Glass Mat                                    | --                | 1 - 2                          |



SAFETY DATA SHEET

Form #: SDS 853027
Revised: AG
Supersedes: AF
ECO #: 1002195

Inorganic lead and sulfuric acid electrolyte are the primary components of every battery manufactured by Tesla™ Products.
There are no mercury or cadmium containing products present in batteries manufactured by Tesla™ Products.

IV. FIRST AID MEASURES

Inhalation:

Sulfuric Acid: Remove to fresh air immediately. If breathing is difficult, give oxygen. Consult a physician
Lead: Remove from exposure, gargle, wash nose and lips; consult physician.

Ingestion:

Sulfuric Acid: Give large quantities of water; do not induce vomiting or aspiration into the lungs may occur and can cause permanent injury or death; consult a physician
Lead: Consult physician immediately.

Skin:

Sulfuric Acid: Flush with large amounts of water for at least 15 minutes; remove contaminated clothing completely, including shoes.
If symptoms persist, seek medical attention. Wash contaminated clothing before reuse. Discard contaminated shoes
Lead: Wash immediately with soap and water.

Eyes:

Sulfuric Acid and Lead: Flush immediately with large amounts of water for at least 15 minutes while lifting lids
Seek immediate medical attention if eyes have been exposed directly to acid.

V. FIRE FIGHTING MEASURES

Flash Point: N/A Flammable Limits: LEL = 4.1% (Hydrogen Gas) UEL = 74.2% (Hydrogen Gas)

Extinguishing Media: Carbon dioxide; foam; dry chemical. Avoid breathing vapors. Use appropriate media for surrounding fire.

Special Fire Fighting Procedures:

If batteries are on charge, shut off power. Use positive pressure, self-contained breathing apparatus. Water applied to electrolyte generates heat and causes it to spatter. Wear acid-resistant clothing, gloves, face and eye protection.
Note that strings of series connected batteries may still pose risk of electric shock even when charging equipment is shut down.

Unusual Fire and Explosion Hazards:

Highly flammable hydrogen gas is generated during charging and operation of batteries. To avoid risk of fire or explosion, keep sparks or other sources of ignition away from batteries. Do not allow metallic materials to simultaneously contact negative and positive terminals of cells and batteries. Follow manufacturer's instructions for installation and service.

VI. ACCIDENTAL RELEASE MEASURES

Spill or Leak Procedures:

Stop flow of material, contain/absorb small spills with dry sand, earth, and vermiculite. Do not use combustible materials. If possible, carefully neutralize spilled electrolyte with soda ash, sodium bicarbonate, lime, etc. Wear acid-resistant clothing, boots, gloves, and face shield. Do not allow discharge of unneutralized acid to sewer. Acid must be managed in accordance with local, state, and federal requirements. Consult state environmental agency and/or federal EPA.

VII. HANDLING AND STORAGE

Handling:

Unless involved in recycling operations, do not breach the casing or empty the contents of the battery.
There may be increasing risk of electric shock from strings of connected batteries
Keep containers tightly closed when not in use. If battery case is broken, avoid contact with internal components.
Keep vent caps on and cover terminals to prevent short circuits. Place cardboard between layers of stacked automotive batteries to avoid damage and short circuits.
Keep away from combustible materials, organic chemicals, reducing substances, metals, strong oxidizers and water. Use banding or stretch wrap to secure items for shipping.

Storage:

Store batteries in cool, dry, well-ventilated areas with impervious surfaces and adequate containment in the event of spills. Batteries should also be stored under roof for protection against adverse weather conditions. Separate from incompatible materials. Store and handle only in areas with adequate water supply and spill control. Avoid damage to containers. Keep away from fire, sparks and heat. Keep away from metallic objects which could bridge the terminals on a battery and create a dangerous short-circuit

Charging:

There is a possible risk of electric shock from charging equipment and from strings of series connected batteries, whether or not being charged. Shut-off power to chargers whenever not in use and before detachment of any circuit connections. Batteries being charged will generate and release flammable hydrogen gas. Charging space should be ventilated. Keep battery vent caps in position. Prohibit smoking and avoid creation of flames and sparks nearby. Wear face and eye protection when near batteries being charged.

VIII. EXPOSURE CONTROLS/PERSONAL PROTECTION

Exposure Limits (mg/m3) Note: N.E.= Not Established

Table with 7 columns: INGREDIENTS (Chemical/Common Names), OSHA PEL, ACGIH, US NIOSH, Quebec PEV, Ontario OEL, EU OEL. Rows include Lead and Lead Compounds, Tin, Sulfuric Acid Electrolyte, Polypropylene, Polystyrene, Styrene Acrylonitrile, Acrylonitrile Butadiene, Styrene, Styrene Butadiene, Polyvinylchloride.

For expanded detailed info, download the PDF online at...
http://www.teslaind.com/PDF/chart/Tesla-Safety-Data-Sheet.pdf.

# Table of Contents

|                                                      |       |
|------------------------------------------------------|-------|
| Section 1 – Safety Review                            | 1     |
| 1.1 – Safety Notices                                 | 1     |
| 1.2 – Symbols                                        | 1     |
| 1.3 – Hazards                                        | 2     |
| 1.4 – Important Safety Precautions                   | 2     |
| 1.5 – Extreme Environments                           | 2     |
| <br>                                                 |       |
| Section 2 – Product Overview                         | 3     |
| 2.1 – Introduction                                   | 3     |
| 2.2 – Indication of Terms: Shall, Should, and May    | 3     |
| 2.3 – Front Panel Overview                           | 4     |
| 2.4 – General Specifications                         | 5     |
| 2.5 – Physical Dimensions                            | 6     |
| 2.6 – Airflow Ports                                  | 6     |
| 2.7 – Operating Positions                            | 7     |
| 2.8 – “Push to Test” Button and LED Status Indicator | 8     |
| 2.9 – Active Power Factor Correction                 | 9     |
| 2.10 – AC Input Circuit Breaker                      | 10    |
| 2.11 – AC Line Cord                                  | 10    |
| 2.12 – 24 Vdc Output Connector                       | 11    |
| 2.13 – Interface Connector                           | 11    |
| <br>                                                 |       |
| Section 3 – Operating Procedures                     | 12    |
| 3.1 – Operating Procedures                           | 12    |
| 3.2 – General                                        | 12    |
| 3.3 – Operating Limits and Restrictions              | 12    |
| 3.4 – Performance                                    | 12    |
| 3.5 – Engine Starting Power                          | 12    |
| 3.6 – Temperature Specifications                     | 13    |
| 3.7 – Environmental                                  | 14    |
| 3.8 – Normal Functional Test Procedures              | 15-16 |
| 3.9 – Pre-Operation                                  | 17    |
| 3.10 – Transporting Unit                             | 17    |
| 3.11 – Regulated 28.5 Vdc Ground Power               | 18-19 |
| 3.12 – Operating with a Digital Volt/Amp Meter       | 19    |
| 3.13 – Regulated AC Power                            | 20    |
| 3.14 – Charging Unit                                 | 21    |
| 3.15 – Circuit Breaker Switch                        | 21    |

|                                                |       |
|------------------------------------------------|-------|
| Section 4 – Post Operation                     | 22    |
| 4.1 – General                                  | 22    |
| 4.2 – After Use                                | 22    |
| 4.3 – Power Cell Recharge                      | 22-23 |
| <br>                                           |       |
| Section 5 – Unit Care and Maintenance          | 24    |
| 5.1 – Unit Care                                | 24    |
| 5.2 – Unit Servicing                           | 25    |
| 5.3 – Packaging and Shipping                   | 25    |
| 5.4 – Storage                                  | 25    |
| <br>                                           |       |
| Section 6 – Troubleshooting and FAQ            | 26    |
| 6.1 – Frequently Asked Questions               | 26-27 |
| 6.2 – Basic Usage/Operation Questions          | 28    |
| 6.3 – Basic Troubleshooting                    | 29-30 |
| <br>                                           |       |
| Section 7 – Performance Data                   | 30    |
| 7.1 – Purpose                                  | 30    |
| 7.2 – General                                  | 30    |
| 7.3 – Data Basis                               | 30    |
| 7.4 – Specific Conditions                      | 30    |
| 7.5 – General Conditions                       | 30    |
| 7.6 – Temperature Conversion Chart             | 30    |
| 7.7 – Output Voltage                           | 33    |
| 7.8 – Maximum Output Current                   | 33    |
| <br>                                           |       |
| Section 8 – Optional Accessories               | 34    |
| 8.1 – Shipping Case                            | 34    |
| 8.2 – GPU Protective Covers                    | 34    |
| 8.3 – Digital Volt/Amp Meter(TI3100A)          | 34    |
| 8.4 – GPU Tires                                | 34    |
| 8.5 – Cobra™ DC Replacement Contacts and Tools | 35    |
| <br>                                           |       |
| Repair Request Form                            | 37    |

# Abbreviations and Symbols

Abbreviations that may be used within the text, headings and titles of this manual.

## LIST OF ABBREVIATIONS



### **Abbreviation**   **Definition**

|          |                                               |
|----------|-----------------------------------------------|
| ac       | Alternating Current                           |
| AFT      | Airflow Technology                            |
| AWG      | American Wire Gauge                           |
| amp or A | Ampere                                        |
| cont     | Continuous                                    |
| °C       | Degree Celsius                                |
| °F       | Degree Fahrenheit                             |
| dc       | Direct Current                                |
| EFF      | Efficiency                                    |
| ft       | Feet                                          |
| FWD      | Forward                                       |
| GPU      | Ground Power Unit                             |
| Hr       | Hour                                          |
| Hz       | Hertz                                         |
| kg       | Kilograms                                     |
| kHz      | Kilohertz                                     |
| kW       | Kilowatts                                     |
| LED      | Light Emitting Diode                          |
| max      | Maximum                                       |
| MΩ       | megaohm                                       |
| min      | Minimum                                       |
| MPU      | Micro Power Unit                              |
| NEMA     | National Electrical Manufacturers Association |
| Ω        | ohm                                           |
| PF       | power factor                                  |
| PFC      | power factor correction                       |
| rms      | root-mean-square                              |
| THD      | Total Harmonic Distortion                     |
| TMDE     | Test, Measurement, & Diagnostic Equipment     |
| UAV      | Unmanned aerial vehicle                       |
| Vac      | Volts, Alternating Current                    |
| Vdc      | Volts, Direct Current                         |
| W        | watts                                         |

# Section 1 – Safety Review

## 1.1 - Safety Notices

Safety notices appear throughout this manual to alert the user to important information regarding proper installation, operation, maintenance and storage of the unit. These notices, as illustrated below, contain a key word that indicates the level of hazard and a triangular icon that indicates the specific type of hazard.

|                                                                                                  |                                                                                                                                    |
|--------------------------------------------------------------------------------------------------|------------------------------------------------------------------------------------------------------------------------------------|
|  <b>WARNING</b> | Indicates a condition, operating procedure or practice, which if not adhered to could result in serious injury or death.           |
|  <b>CAUTION</b> | Indicates a condition or operating procedure, which if not strictly adhered to could result in damage or destruction of equipment. |
|  <b>NOTE</b>    | Indicates a condition, operating procedure or practice, which is essential to highlight.                                           |

## 1.2 - Symbols

The following symbols will appear within the warning triangles to alert the user to the specific type of danger or hazard.



Figure 1.2.1 – Different types of hazard and caution symbols



### 1.3 – Hazards



#### WARNING

Shock Hazard Potential

Severe injury or death from electrical shock will occur if either the user or the unit is wet while operating the unit with the 200-260 Vac power source attached. Be sure to disconnect ac power from the ac source if the unit has come into contact with water. If the AC Input Circuit Breaker has tripped due to water infiltration, DO NOT try to reset circuit breaker until GPU has dried completely.



#### WARNING

Shock Hazard Potential

Severe injury or death from electrical shock can occur when damp electrical plugs are connected to the unit. Make sure the electrical outlet is switched off before making any connections. Failure to use proper grounding can cause potential shock hazard!

#### CAUTION

Unit Damage Potential

The unit will be damaged if unapproved ac power is applied. This Unit operates from Single Phase 200-260 Vac, 40 Hz - 450 Hz. This must match ac power source (hangar wall, flight line ac power) prior to connecting the unit.

### 1.4 – Important Safety Precautions



#### WARNING

Fire/Explosion Hazard Potential

Severe injury or death from fire or explosion can occur if electrical sparks are produced near fuel vapors. Power output is 28.5 Vdc. DO NOT CONNECT ac power to GPU while operating or handling any aircraft fuel.

### 1.5 – Extreme Environments



#### CAUTION

Unit Damage Potential

The unit is equipped with a charger temperature switch that automatically disables ac and charging functions when the internal temperature reaches above 150°F (65°C). This protects the unit from overheating and damage. If the unit shuts down, move the unit into a cooler climate such as shade or air conditioning when possible. Perform a full function test prior to use after the unit has been allowed to cool.

## Section 2 – Product Overview

### 2.1 – Introduction

This manual contains the complete operating instructions and procedures for the TI4200 GPU-24-PFC ground power unit. The TI4200 GPU-24-PFC provides dc electrical ground power for aircraft flight line and maintenance ground support operations. The unit is designed to provide 24 Vdc electrical power output for aircraft engine starting and 24 or 28.5 Vdc electrical support for ground maintenance, avionics/electrical trouble shooting and testing. The observance of procedures, limitations and performance criteria ensures peak operating efficiency and maximizes operational capabilities and life of the TI4200 GPU-24-PFC.

This GPU is one of Tesla™ Industries latest advancements in power technology development. This GPU features a 6.5kW active Power Factor Correction (PFC) that is capable of pulling a current waveform identical to the applied voltage waveform. This is the only PFC on the market that is capable of operating at 40 Hz to 450 Hz with 2% THD (Total Harmonic Distortion).

What this means for the end user is that this GPU is capable of producing the same output power of one of our three phase GPU's while operating off of single phase power. It offers a wide versatility of power options while effectively lowering energy consumption.

The TI4200 GPU-24-PFC was designed to provide 200 amps @ 28.5 Volts of pure regulated flat line dc power for vehicle ground support, avionics, battery charging, power for training facility operations, and for all 24 Volt systems.

This manual contains the operating instructions and procedures for the TI4200 GPU-24-PFC needed to safely and efficiently operate this GPU.

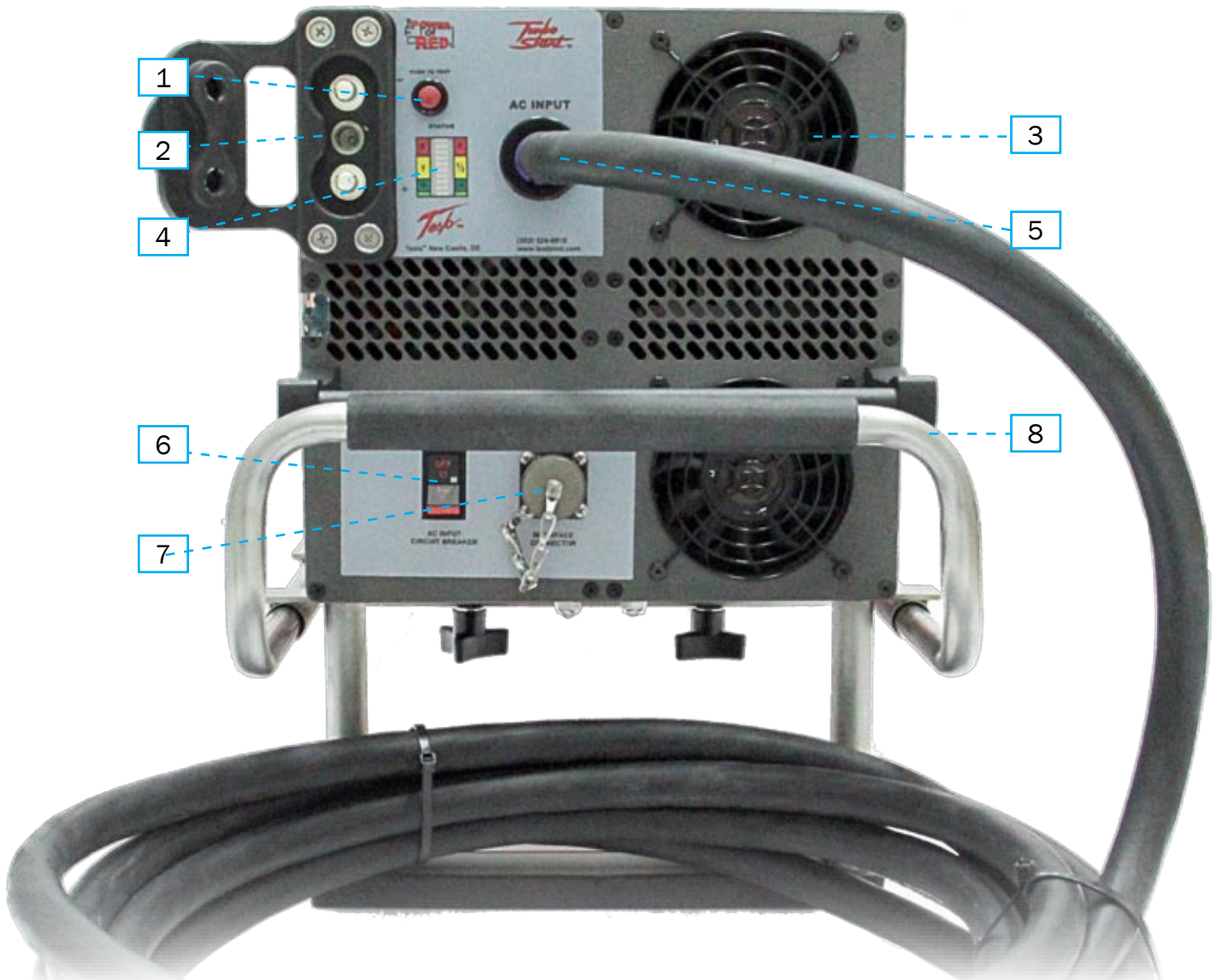

Figure 2.1.1 – TI4200 GPU-24-PFC

### 2.2 – Indication of Terms: Shall, Should and May

Within this technical manual the word “shall” is used to indicate a mandatory requirement for proper operation and warranty purposes. The word “should” is used to indicate a non-mandatory but preferred method of accomplishment. The word “may” is used to indicate an acceptable method of accomplishment.

## 2.3 – Front Panel Overview



1. **“Push to Test” Button** – Displays current battery charge state when pressed.
2. **DC Output Receptacle** – Provides output of 28.5 Vdc @ 200 amps (3000 amps peak)
3. **Air Intake Fan** – Provides active cooling for internal components.
4. **LED Charge Status Meter** – Displays current battery charge status when pressed.
5. **50 Amp Twist-Lock AC Power Cord** – Provides 33.5 amps @ 208 Vac 60Hz (50 amp service required).
6. **External AC Circuit Breaker** - Protects the internal electrical circuit from damage caused by overload or short circuit.
7. **Interface Connector** - Used for factory calibrations.
8. **Telescopic Handle** – Allows for easy transport of unit (removed to show panel).

## 2.4 – General Specifications

### Electrical

#### AC Input Power:

- Single Phase 200-260 Vac / 40 Hz - 450 Hz
- 33.5 amps @ 208 Vac
- 50 amp Service Required
- Contact Tesla™ Industries for Plug Configuration

#### Power Cell:

- Dry, High Rate Discharge, Rechargeable , Maintenance-free

#### PFC:

- .999% power factor
- <2% THD (Total Harmonic Distortion)

#### DC Output:

- 1500 peak starting amps
- 200 amps continuous @ 28.5 Vdc - 5700 Watts (when plugged into ac power)
- 223 amp hours (6,212 watt hours) with ac power
- 23 amp hours (512 watt hours) of rechargeable battery power without ac power

#### Rechargeable Rate:

- 12 minutes (from full discharge) @ 25 °C

#### Size:

- 49" long x 19.25" wide x 16" high
- 1244.6 mm x 488.95 mm x 406.4 mm

#### Weight

- 139 lbs (63.25 kg)

#### Operating Temperature:

- -40 °C to +60 °C (-40 °F to 140 °F) without ac power
- -40 °C to +55 °C (-40 °F to 131 °F) with ac power

#### Storage Temperature:

- -65 °C to +105 °C (-85 °F to 221 °F)

#### Cell Capacity:

- +40 °C 110% ± 05%
- +25 °C 100% ± 05%
- +00 °C 80% ± 05%
- -20 °C 65% ± 10%
- -40 °C 50% ± 10%

## 2.5 – Physical Dimensions

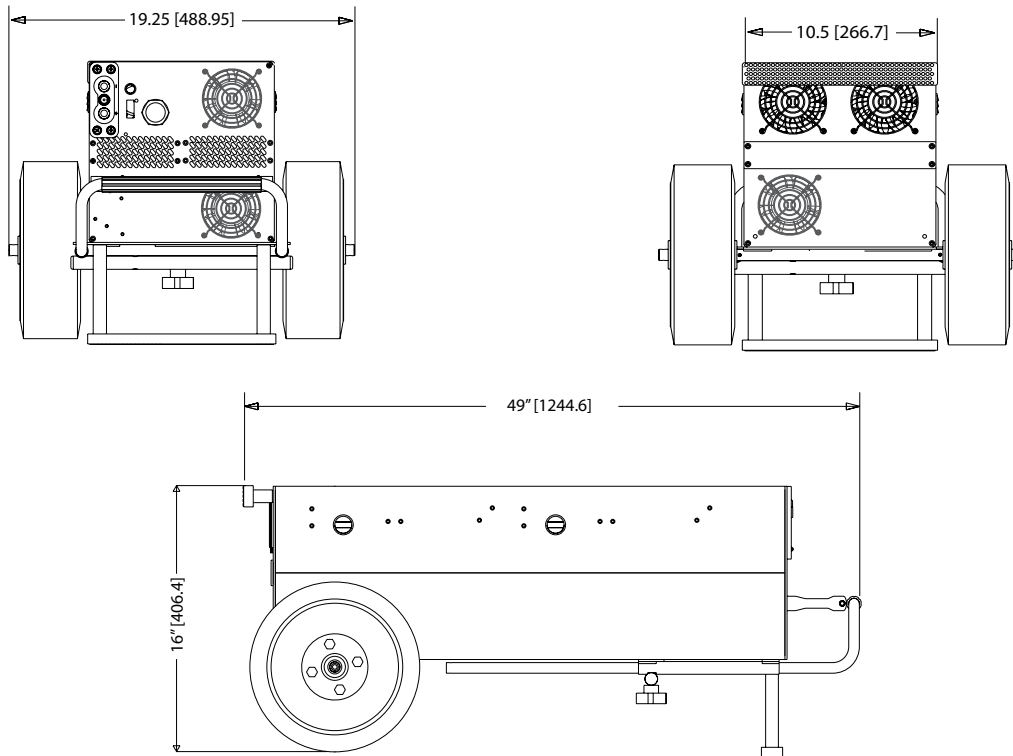

Figure 2.5.1 – TI4200 GPU-24-PFC physical dimensions

## 2.6 – Airflow Ports



### CAUTION

Damage may occur if the unit's air intake or outlet ports are obstructed. Ensure that ports are clear at all times.

When the unit is plugged into ac power, the internal cooling system will efficiently regulate unit temperature regardless of load. At room temperature (+77 °F) the exhaust air will not exceed the ambient temperature by more than 5 °F. In more extreme temperatures (greater than 90 °F) the exhaust air will not exceed the ambient temperature by more than 10 °F.

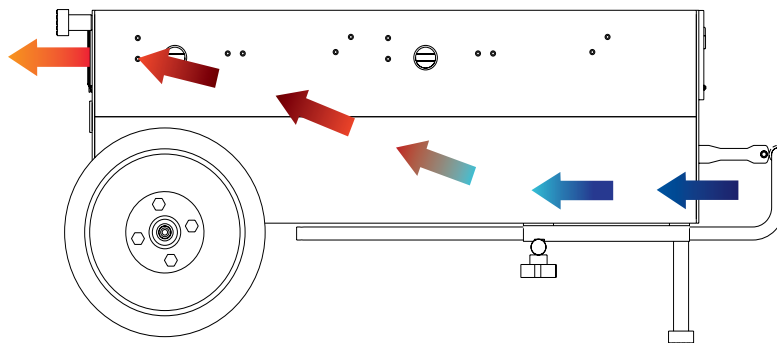

Figure 2.6.1 – Air intake and exhaust ports and internal air circulation

## 2.7 – Operating Positions

The TI4200 GPU-24-PFC can be operated in both the horizontal (Figure 2.7.1) and vertical (Figure 2.7.2) positions as shown. Make sure that the airflow is not obstructed from air intake (figure 2.7.3) and outlet (Figure 2.7.4).

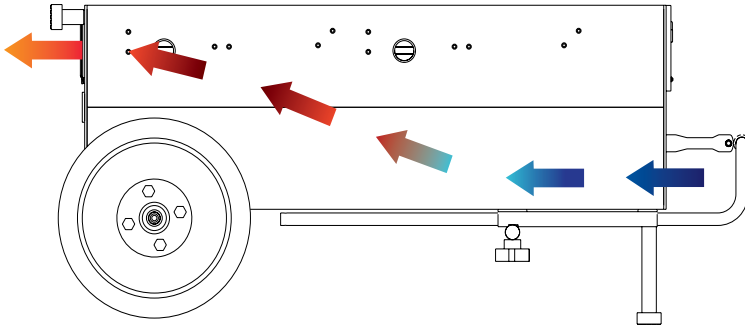

Figure 2.7.1: Horizontal Position

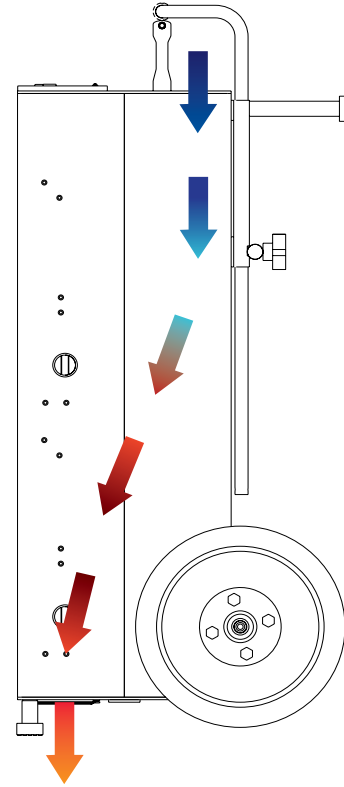

Figure 2.7.2: Vertical Position

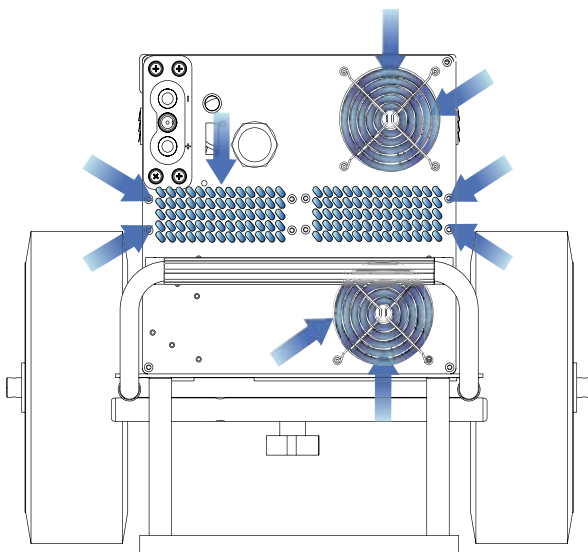

Figure 2.7.3: Front Inlet

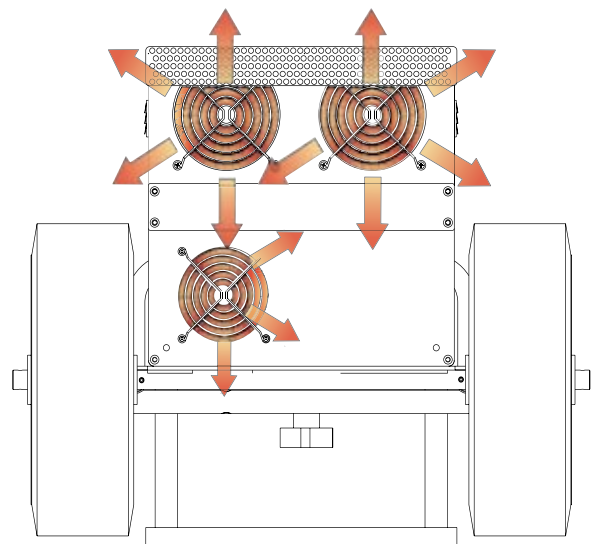



Figure 2.7.4: Rear Outlet



## 2.8 – “Push to Test” Button and LED Status Indicator

The “Push to Test” button indicates the capacity of the power cells without applying ac input power. The status of the capacity lets the user know if there is enough power to perform another engine start. When the capacity is low the unit should be connected to ac power to allow it to recharge.

1. Make sure that you wait at least 2 minutes after ac power is applied, or dc power is extracted from the unit, before you press the “Push to Test” button. This ensures a correct reading.
2. Without ac power input or dc power output, simply press the “Push to Test” button on the faceplate and hold for approximately 2 to 3 seconds.
3. The LED bar graph should light up indicating the status of the power cells.
4. In addition, the fan(s) should start operating when the button is pressed. If you do not hear the fan(s) running, stop pressing the button and check for any obstructions.

|                                                                                                  |                                                                                                     |
|--------------------------------------------------------------------------------------------------|-----------------------------------------------------------------------------------------------------|
|  <b>CAUTION</b> | Never press the “Push to Test” button while the unit is plugged into aircraft, vehicle or ac power. |
|--------------------------------------------------------------------------------------------------|-----------------------------------------------------------------------------------------------------|

|                                                                                                  |                                                                                                                                                                                                                                                            |
|--------------------------------------------------------------------------------------------------|------------------------------------------------------------------------------------------------------------------------------------------------------------------------------------------------------------------------------------------------------------|
|  <b>CAUTION</b> | Never press the “Push to Test” button for more than 5 seconds. This may cause a temperature sensor to temporarily disrupt “Push to Test” function. (If this sensor is tripped, allow ten minutes for unit to cool before operating “Push to Test” button.) |
|--------------------------------------------------------------------------------------------------|------------------------------------------------------------------------------------------------------------------------------------------------------------------------------------------------------------------------------------------------------------|

|                                                                                                 |                                                                                                                                                                                                                                                                   |
|-------------------------------------------------------------------------------------------------|-------------------------------------------------------------------------------------------------------------------------------------------------------------------------------------------------------------------------------------------------------------------|
|  <b>NOTE</b> | If unit is left charging after the batteries are fully charged, the unit will enter a <b>standby mode</b> . The voltage will drop from 28.60 to 28.10 volts ( $\pm 0.10$ ). When a load greater than 2 amps is applied, the unit will return to normal operation. |
|-------------------------------------------------------------------------------------------------|-------------------------------------------------------------------------------------------------------------------------------------------------------------------------------------------------------------------------------------------------------------------|



Figure 2.8.1 - Pushing to Test

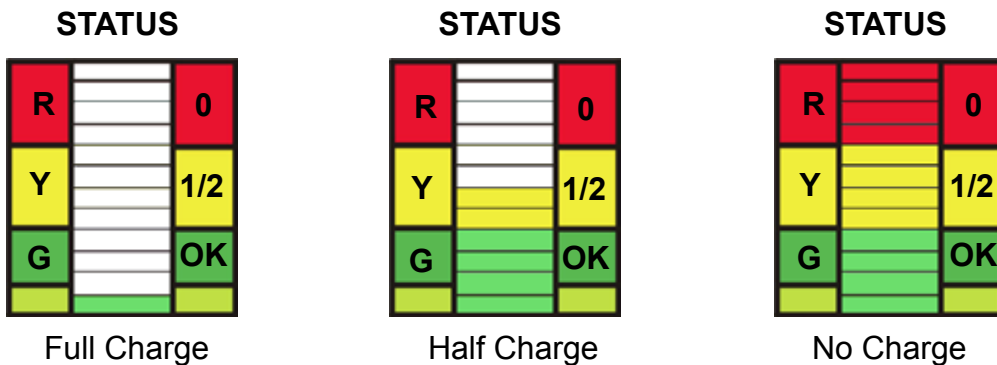

## 2.9 – Active Power Factor Correction

In electric power systems, a power supply with a low Power Factor will draw more current than the same power supply with a high Power Factor while doing the same work.

Power Factor (PF) in ac systems is defined as the ratio of the real power W (watts) flowing to the load over the apparent power VA (volts-amps) in the circuit. This is represented by a number between 0 and 1. For example: this is a percentage .75PF=75%PF.

A power supply is considered to be a non-linear load in which the ac power is rectified and then filtered. It is these non-linear loads that reshape the current waveform into something different introducing harmonics and distortion known as THD (Total Harmonic Distortion).

THD is defined as the ratio of the sums of all the powers of the harmonics to the power of the fundamental frequency (i.e. the fundamental frequency would be the line frequency 60 Hz and the 2nd order harmonic=120 Hz, the 3rd order=240 Hz, etc.).

$$\text{THD} = \sqrt{\frac{\sum_{n \neq 1} I_n^2}{I_1^2}} \quad \text{PF} = \sqrt{\frac{1}{1 + \text{THD}^2}}$$

When the mains instantaneous voltage exceeds the voltage of the Input Capacitors the Rectifiers conduct which causes a current spike (see Figure 2.9.1). These spikes induce harmonics and distortion. These additional harmonics over the fundamental frequency are what contribute to a poor Power Factor. The higher order harmonics in the ac current cause the skin effect of the conductors carrying the ac currents to the load to increase.

Skin effect in ac circuits is where the higher frequency currents do not penetrate the entire conductor due to the opposing eddy currents causing them to ride along the surface of the conductor. It is these magnetic fields, generated by the eddy currents, which cause the resistivity of the conductor to increase with frequency.

This means the conductor needs to carry additional currents plus the load current to compensate for the higher order harmonics. These extra currents generate magnetic fields and are stored in the power lines, the switch gear and the power supply. They then return back to the power grid during the off periods of the cycle resulting in wasted energy in the form of heat.

Tesla™ Industries was able to develop a wide bandwidth active Power Factor Correction that runs from 40 Hz to 450 Hz which pulls unity power only at the fundamental frequency. This was achieved by forcing the current to follow the voltage waveform (see Figure 2.9.2) so that current is pulled through the entire sinusoidal waveform on a cycle-by-cycle basis. This eliminates the current spikes and strips out the additional harmonics causing a massive increase in efficiency.



Figure 2.9.1 - Non-PFC Power Supply



Figure 2.9.2 - Tesla's PFC Power Supply



### 2.10 – AC Input Circuit Breaker

This unit is equipped with a 35 Amp AC Input Circuit Breaker located above the AC Input Connector. The AC Input Circuit Breaker acts as an “On/Off” switch for the unit.

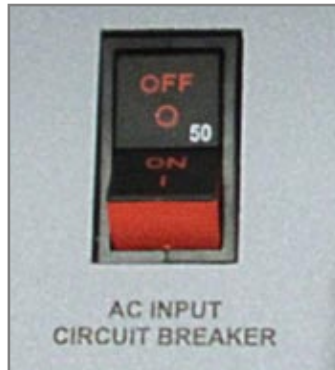

Figure 2.10.1 - AC Input Circuit Breaker

### 2.11 – AC Line Cord

The ac line cord is a 25' long S00W 600 Volt 8/3 Cable with a 50 Amp Twist Lock. (TI25000-058 (CS8265) 25ft. Hardwired Single Phase Plug AC Line Cord ) 50 Amp service is required to use the unit. Contact Tesla™ Industries for additional plug configurations.



Figure 2.11.1 50 Amp Twist Lock AC Line Cord

## 2.12 – 24 Vdc Output Connector

The 24 Vdc Output Connector will provide 100 Amps of continuous power @ 28.5 Vdc (when plugged into ac power). When the Output Connector is not in use, cover the receptacle with the protective cover (see Figure 2.12.1). This will protect the Output Connector from dust and foreign matter.

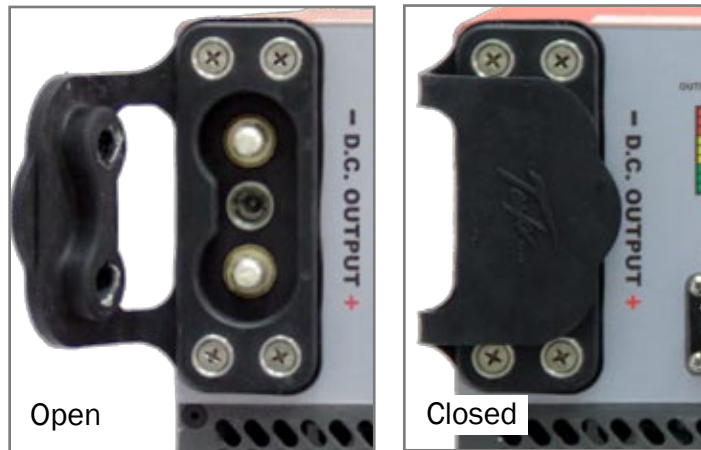

Figure 2.12.1 24 Vdc Output Connector Protective Cover

## 2.13 – Interface Connector

The Interface Connector is used by a Tesla™ factory technician to calibrate the unit.





Figure 2.13.1 - Interface Connector location

# Section 3 – Operating Procedures

## 3.1 – Operating Procedures

This section covers normal procedures and steps necessary to ensure safe and efficient operation of the unit.

|                                                                                               |                                                                                                                                      |
|-----------------------------------------------------------------------------------------------|--------------------------------------------------------------------------------------------------------------------------------------|
|  <b>NOTE</b> | When not in use, the unit should always remain plugged into a suitable ac power source to ensure operational readiness at all times. |
|-----------------------------------------------------------------------------------------------|--------------------------------------------------------------------------------------------------------------------------------------|

|                                                                                               |                                                                                                                                                                                                                                                                     |
|-----------------------------------------------------------------------------------------------|---------------------------------------------------------------------------------------------------------------------------------------------------------------------------------------------------------------------------------------------------------------------|
|  <b>NOTE</b> | If current demand exceeds 200 amps, converter output voltage will drop below 28.5 Vdc and two or more LED status indicator bars will illuminate. If all LED status indicator bars illuminate, both the converter and power cells are supplying 24 Vdc power output. |
|-----------------------------------------------------------------------------------------------|---------------------------------------------------------------------------------------------------------------------------------------------------------------------------------------------------------------------------------------------------------------------|

## 3.2 – General

The user should be well-versed in both pre-use and functional checks for correct operations of this unit. Knowledge of the operating limits, restrictions, performance, unit capabilities and functions aids in correct and safe operations. Compliance with the instructions in this manual affect operational safety as well as the warranty of the unit.

## 3.3 – Operating Limits and Restrictions

The minimum, maximum and normal operating ranges result from careful engineering and evaluation of test data. These limitations must be adhered to during all phases of operation.

## 3.4 – Performance

Refer to Section 7, PERFORMANCE DATA to determine the capability of the unit. Consideration must be given to changes in performance resulting from variations in ambient temperature, mode of operation, state of charge (with or without ac power), and aircraft dc bus system inefficiency (voltage drops).

## 3.5 – Engine Starting Power

The unit should always be charged above 80% prior to ground support engine starting. However, circumstances may exist during use where unit recharge is not readily available and immediate external engine starting power is required. The following provides minimum states of charge necessary to provide ample power for an efficient engine start under specific current load demands.

### ENGINE START PEAK CURRENT Requirements

- Under 650 peak starting amps
- 650 - 850 peak starting amps
- 850 - 1000 peak starting amps
- 1000 - 1200 peak starting amps
- 1200 - 1500 peak starting amps

### MINIMUM CHARGE

- 0-50% charged
- 50-60% charged
- 60-70% charged
- 70-80% charged
- 80-100% charged

## 3.6 – Temperature Specifications

### Cold/Hot Soaked Temperature

Exposing the unit for one (1) hour or more to the ambient temperature establishes the unit's cold/hot soaked stabilization temperature. If the unit's cold/hot soaked temperature is outside the normal operating temperature range, the unit must be stabilized prior to operation. For COLD SOAKED temperature stabilization, the unit must be placed in an environment with a temperature above +10°C (+41°F) for 3 hours or a temperature above +20°C (+68°F) for 2 hours. For HOT SOAKED temperature stabilization, the unit must be placed in an environment with a temperature below +38°C (+100°F) for 1 hour.

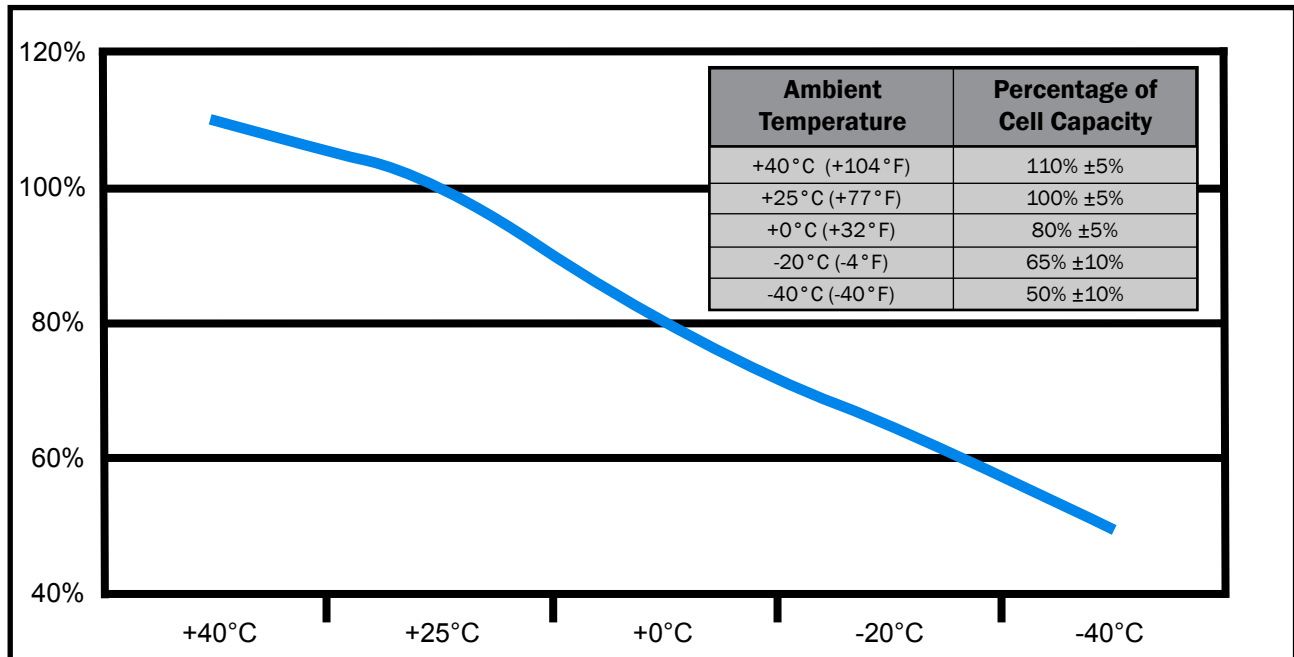

Figure 3.6.1 – Output power capability versus ambient temperature

### Hot Soaked or Cold Soaked Definition

Simple terms: When a material is exposed to a change in temperature, its temperature will also change. Some material changes temperature quickly, others slowly. If the ambient temperature changes and is then held constant, the materials temperature will also change until its temperature stabilizes. Once the material temperature has stabilized, it is considered “soaked”.

Example: A unit is moved from the cool shade into the hot sun. That unit's temperature will increase until it stabilizes. Once stabilized, the unit would be considered “hot soaked”.



#### NOTE

The unit's temperature switch automatically disables ac power functions when the internal temperature is above 150°F (65°C). This protects the unit from overheating and damage. If the unit shuts down, move the unit into a cooler climate, such as shade or air conditioning when possible. Perform a full function test prior to use after the unit has been allowed to cool.

3.7 – Environmental

|                                                                                                                                               |                                                                                                                                                                                                                                                                                                                           |
|-----------------------------------------------------------------------------------------------------------------------------------------------|---------------------------------------------------------------------------------------------------------------------------------------------------------------------------------------------------------------------------------------------------------------------------------------------------------------------------|
|  <b style="font-size: 1.2em; margin-left: 10px;">WARNING</b> | <p>Operating any electrical equipment in the presence of moisture creates possible safety hazards and/or potential for equipment damage. Every effort has been made, within the scope of existing technology to prevent foreseeable safety hazards and make the unit moisture resistant to prevent damage or failure.</p> |
|-----------------------------------------------------------------------------------------------------------------------------------------------|---------------------------------------------------------------------------------------------------------------------------------------------------------------------------------------------------------------------------------------------------------------------------------------------------------------------------|

If the unit is exposed to moisture, preventive measures and precautions shall be taken to:

- A. Prevent accumulation of moisture on ac and dc connectors/receptacles
- B. Minimize moisture entering forward inlet and aft outlet cooling fan vent ports

Unit inlet and outlet vent ports shall be covered from exposure. Unit shall be kept horizontal. Recommendations include a Protective Rain Cover to guard the unit from moisture (see Section 8). The limits and operational constraints listed below shall apply for the following environmental (weather) conditions:

| Conditions                                                                                                                                                           | With Raincover | Without Raincover         |
|----------------------------------------------------------------------------------------------------------------------------------------------------------------------|----------------|---------------------------|
| <b>Heavy or steady rain:</b><br><i>Precipitation falling with an intensity in excess of 0.30 inch (0.76 cm) or continuously between 0.30 and 0.10 inch per hour.</i> | OK             | OPERATION NOT RECOMMENDED |
| <b>Light rain, drizzle or sleet:</b><br><i>Precipitation falling on a continuous basis between 0.10 inch and less than 1/50 inch (0.5 mm) per hour</i>               | OK             | DC OPERATIONS ONLY        |
| <b>Heavy or steady snow:</b><br><i>Generally meaning an accumulation between 4 inches and less than 1 inch in a 12 hour period.</i>                                  | OK             | OPERATION NOT RECOMMENDED |
| <b>Light snow:</b><br><i>Snow falling intermediately with little or no accumulation.</i>                                                                             | OK             | DC OPERATIONS ONLY        |
| <b>Fog:</b>                                                                                                                                                          | OK             | OK                        |



Figure 3.7.1 – TI4200 GPU-24-PFC with TI7000-104 Protective Rain Cover

### 3.8 – Normal Function Test Procedures

This section involves “normal function” test procedures, and includes steps necessary to ensure that the unit is operating within specified parameters prior to use. A digital multimeter (an example is shown in Figure 3.8.1) capable of measuring dc and ac voltage and resistance will be required to perform some of the tests. These functional test procedures should become routine.



Figure 3.8.1 – Digital Multimeter

#### Check Unit for Evidence of Damage

Check for dents, punctures, case distortion or misalignment, and cracked or loose connectors. If no damage is evident, proceed to the next step. If damage is evident, contact Tesla™ Industries, Inc.



Figure 3.8.2 – Damaged Unit  
Misaligned Case with Bent Faceplate

## Check Unit Internal Resistance (Test for Shorts)

**NOTE**

Unit should be disconnected from any ac power sources prior to testing.



1. Place the negative probe on the ac ground probe and the positive probe on the case.



2. Move the positive probe to the dc positive post.



3. Move the positive probe to the dc negative post.

Better than 10 M $\Omega$ , Ensure no short exists.

Negative(-) DC receptacle terminal and unit case.

Positive (+) DC receptacle terminal and unit case.

## Check DC Voltage Reading at DC Receptacle Terminals

26.5 to 28 Vdc depending on state of charge.



Figure 3.8.3 – Testing DC Receptacle

**NOTE**

If unit is left charging after the batteries are fully charged, the unit will enter a **standby mode**. The voltage will drop from 28.60 to 28.10 volts ( $\pm 0.10$ ). When a load greater than 2 amps is applied, the unit will return to normal operation.



### 3.9 – Pre-Operation

1. Be sure to check that all input and output cables are not damaged. (see section 5.1)
2. Check unit carefully for any evidence of damage. (see section 3.8)
3. Make sure that airflow is not obstructed from air intake and outlet. (see section 2.6)
4. Check that all connections are secure and free from water.



Figure 3.9.1 TI4200 GPU-24-PFC

### 3.10 – Transporting Unit

The TI4200 GPU-24-PFC has a telescoping handle that makes rolling the unit easy. For transporting on uneven ground, axle extensions should be added to the unit. For use on sand, balloon tires should be installed on the unit (see Optional Accessories).



Figure 3.10.1 Releasing Telescopic Handle



### 3.11 – Regulated 28.5 Vdc Ground Power

#### Connecting DC Power Cable To Unit

Ensure dc power cable plug is fully seated into the GPU's DC Battery Receptacle. Attaching a dc plug is quick and easy. Line up the plug with the receptacle. Push forward while rotating the T-handle one full turn clockwise. The unit is now ready to safely transfer power.



Figure 3.11.1 Attaching DC Power Cable to TI4200 GPU-24-PFC

#### Connecting DC Power Cable To Vehicle or Aircraft

Line up the NATO plug or aviation dc plug pins and push it in. DC bus power should come on and aircraft voltmeter should indicate 24 Vdc to 23.5 Vdc (23 Vdc minimum). Ensure dc power cable plug is fully seated into the vehicle or aircraft's dc receptacle.



Figure 3.11.2 Attaching NATO DC Power Cable to vehicle

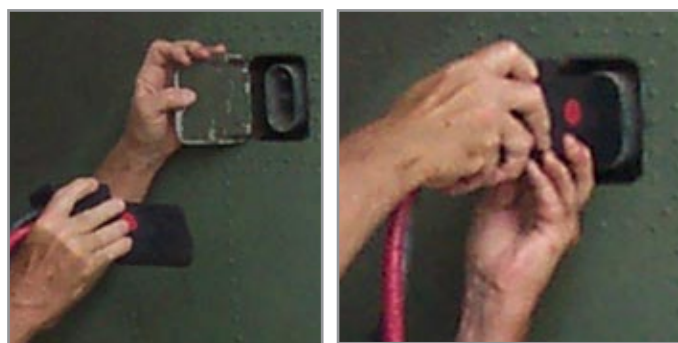

Figure 3.11.3 Attaching an Aviation DC Power Cable to aircraft

#### Low Power Demand

Low power demand is defined by a requirement of 200 amps or less. Connect dc power to aircraft ground power receptacle. DC bus power should come on and aircraft voltmeter should indicate 28.5 Vdc to 27 Vdc (26.5 Vdc minimum). If aircraft power demand is less than 200 amps converter output will remain at 28.5 Vdc (only one GREEN LED status indicator bar will illuminate). If aircraft power demand exceeds 200 amps converter voltage output will decrease and two or more LED status indicator bars will illuminate.

## High Power Demand

High power demand is defined by a requirement of more than 200 amps. Connect to aircraft ground power receptacle. DC bus power should come on and aircraft voltmeter should indicate 27.5 Vdc to 23.5 Vdc (23 Vdc minimum). If current demand is above 200 amps, converter output voltage will drop below 28.5 Vdc and two or more LED status indicator bars will illuminate. If the red LED status is displayed, the unit has dropped down to 24.5 Vdc.



### NOTE

When all LED status indicator bars illuminate, both the converter and power cells are supplying 24 Vdc power output for current demands above 200 amps.

## Engine Starting



### CAUTION

Unplug ac power cord before starting engine with unit.

Prior to engine start, ensure power cell charge is sufficient to provide an efficient engine start. Check dc power cable for secure and correct installation prior to engine starting. Follow ground power engine starting procedure as specified in vehicle operator's manual.



Figure 3.11.3 Starting vehicle with TI4200 GPU-24-PFC

## Removing DC Power Supply From Aircraft or Vehicle

1. Remove dc power cable GPU connector from vehicle.
2. Remove dc power cable connector from TI4200 GPU-24-PFC (if necessary).
3. Reinstall dc receptacle's protective cover.

## 3.12 – Operating with a Digital Volt/Amp Meter

The DVAM (Digital Volt/Amp Meter) 3100A provides measurements for all voltage ranges and amperage draws between zero and 2,000. The DVAM 3100A indicates the aircraft or vehicle's current demand. Integrated with the Tesla™ GPU power supply, the DVAM is a valuable tool for troubleshooting and system checks.

The left meter indicates dc voltage output and the right meter indicates amperage draw. The meter's range changes from 0-200 amps to 0-2,000 AMPS with the flip of a switch. The 200 amp setting provides a more detailed reading extending to two decimal places. The 2,000 amp setting reads higher currents such as engine starts and in rush currents.



Figure 3.12.1 DVAM 3100A

### 3.13 – Regulated AC Power

#### Plugging in with AC Power

When the TI4200 GPU-24-PFC is plugged into ac power, the output is 28.5 volts. This voltage allows the system to recondition and recharge the vehicle's battery(ies). It is also an optimum voltage for powering avionics and lighting on most aircraft. The GPU's ac to dc converter produces continuous amps of dc power depending on the size of the system.



Figure 3.13.1 Connecting TI4200 GPU-24-PFC to AC Power Supply

#### Connect DC Power Cable To Unit

Ensure dc power cable connector is fully seated into unit's receptacle (if necessary).



Figure 3.13.2 Connecting TI4200 GPU-24-PFC to AC Power Supply with DC Power Cable Attached

### 3.14 – Charging Unit

Once you have the fuse set to match the power characteristics of your line cord, you can plug the unit into a wall socket to charge the batteries. Until the unit is fully charged, the LED status will read half or no charge.



Figure 3.14.1 Connecting TI4200 GPU-24-PFC to AC Power Supply

If you received this manual with a new GPU.

Under a full charge the LED indicator should show a single steady green bar or a single green bar blinking. The fan will also come on at reduced speed. This is normal operation indicating the unit is in standby mode and is ready for use.

If you own an older GPU and this is a replacement manual.

Under a full charge the LED indicator should show a single steady green bar or the entire LED will be blinking. The fan will also exhibit ratcheting but will not come on. This is normal operation indicating the unit is in standby mode and is ready for use.

If the GPU's cells need to be replaced.

After one and a half hours (90 minutes) of ac power input the unit should be fully charged. If the “Push to Test” button is pressed and the unit still indicates it is not fully charged then the cells should be replaced.



#### CAUTION

The ON/OFF switch located on the faceplate does not control the DC output power function.

### 3.15 – Circuit Breaker Switch

The TI4200 GPU-24-PFC comes equipped with a circuit breaker switch on the front faceplate. This switch controls ac power input only, It does not control the dc output power to the aircraft or vehicle. Whenever the unit is plugged into an aircraft or vehicle, it is supplying dc power.

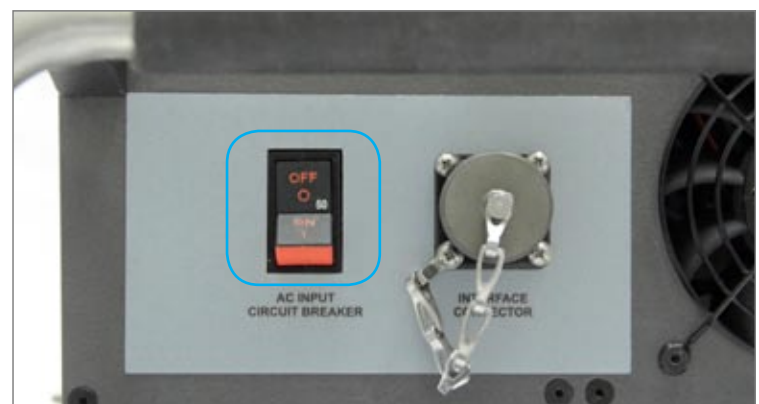

Figure 4.2.1 Circuit Breaker Selector Switch  
(outlined in blue)



## Section 4 – Post Operation

### 4.1 – General

Although the TI4200 GPU-24-PFC has been ruggedized and made weather resistant within the scope of unit's intended use, it is essential that good general care be taken to maintain unit in good operating condition and to maximize unit's operational life.

### 4.2 – After Use

Unit should be protected from environmental elements and man made hazards. Ideally unit should be secured in a building or shed. Most importantly, unit shall be fully covered if stored while exposed to environmental elements.

### 4.3 – Power Cell Recharge



#### NOTE

The TI4200 GPU-24-PFC incorporates a backcharge feature that enables the unit to be recharged from the vehicle once the engine is started and the starter/generator is running. This feature will enable you to start multiple vehicles without reconnecting to ac power if the GPU is allowed to backcharge for approximately 30 seconds.



#### NOTE

Plug the TI4200 GPU-24-PFC into ac power to keep the cells charged whenever it is not in use, even if it is at Full Charge. The unit will not overcharge or overheat.

### Connect AC Power Cord to Unit

Ensure power cord is properly connected to an approved ac power supply. After approximately 5-8 seconds, ensure unit's LED status indicator illuminates indicating power cell state of charge and cooling fan is operating.

Any time the unit's power cells are fully discharged the unit shall be recharged within 24 hours to prevent performance degradation and ensure maximum life.

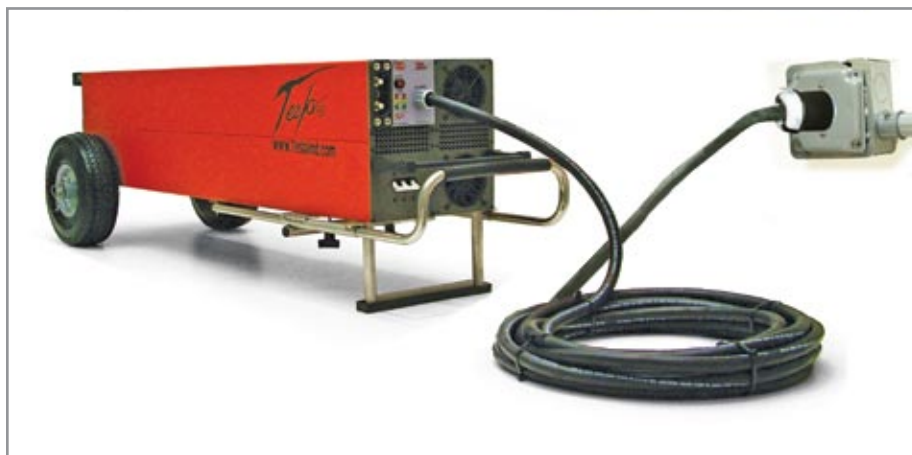

Figure 4.3.1 Connecting TI4200 GPU-24-PFC to AC Power Supply

**CAUTION****Guard From Incorrect Power Source**

The GPU's power cells may be damaged if recharged by NiCad or Lead Acid-type battery chargers. Power cells should only be charged by either the GPU's internal charger and the ac power cord furnished with the equipment, or when connected to aircraft's external dc power receptacle.

**NO**

Figure 4.3.2 Proper and Improper Charging Methods

## Section 5 – Unit Care and Maintenance



### WARNING

Severe injury or death from electrical shock may occur, if either the user or the unit is wet, while the unit is connected to a power source.



### CAUTION

The use of unapproved or modified ac line cable or input plug may damage the unit. Do not use any type of ac voltage converter.

### 5.1 - Unit Care

#### Avoid Prolonged Exposure to Extremely Damp Environments

If the unit has come into contact with water, disconnect ac power from the ac source. If the AC Input Circuit Breaker has tripped due to water infiltration, allow the unit to dry out before attempting to reset circuit breaker. Cover the unit to prevent water seepage. If the unit is operated in extremely damp conditions, it should be stored in an environmentally controlled building when not in use. Wipe unit clean periodically with a soft cloth to remove dust, dirt, etc.



#### Protect Cables from Damage

Do not cut, crush, or drag the input or output power cables when handling the unit. Always inspect cables prior to use. If no damage is evident, proceed to the next step. If damage is evident, contact Tesla™ Customer Service. Do not attempt to use any other type of power cables other than the Tesla™ cables included with the unit.



Figure 5.1.1 – Damaged cable

## 5.2– Unit Servicing

This unit is a maintenance-free, sealed unit. No repairs outside of Tesla™ are authorized. Warranty will be voided if unit is tampered with in any way including any damage to the WARRANTY VOID stickers located on the case (see Figure 5.2.1 below). If the unit requires maintenance, please contact Tesla™ Customer Service at (302) 324-8910. A Repair Request Form can be found in the back of this manual.

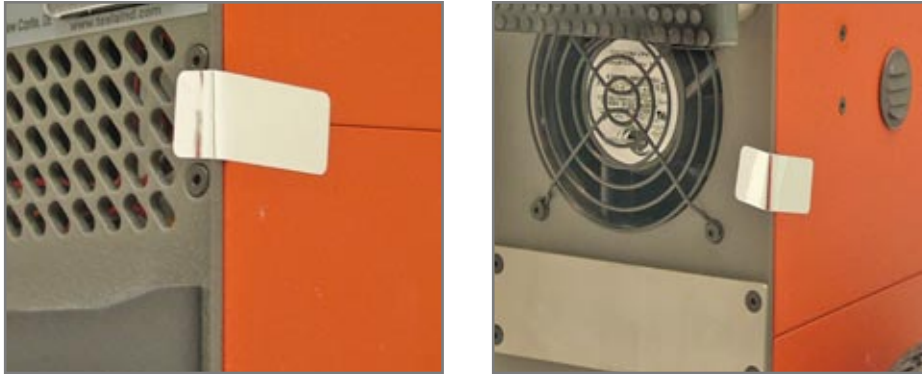

Figure 5.2.1 – Warranty Void stickers Front and Back on the unit

## 5.3 – Packaging and Shipping

Ensure proper packaging when returning the unit. Transport the unit only in a sturdy shipping crate or Tesla™ Shipping Case. It is important to enclose the Repair Request Form. Seal the crate on all sides and return it to Tesla™ at the address listed below. Please contact Tesla™ Customer Service at (302) 324-8910 with any questions or concerns.

TESLA™ INDUSTRIES, INCORPORATED  
101 CENTERPOINT BLVD.  
CENTERPOINT INDUSTRIAL PARK  
NEW CASTLE, DELAWARE 19720  
PHONE: (302) 324-8910 FAX: (302) 324-8912  
Website: [www.teslaind.com](http://www.teslaind.com) ♦ [www.tesla1.com](http://www.tesla1.com)  
Email: [Tesla1@teslaind.com](mailto:Tesla1@teslaind.com)



Figure 5.3.1 – Tesla™ Shipping Case

## 5.4 – Storage

If unit can not be connected to ac power while in storage, we recommend to charge the unit once a year. The shelf-life of 12 months is due to the battery /cells inside the unit. We guarantee the unit will hold 80% of its charge for a period of 12 months without being recharged. When the GPU's leave the facility, they are fully charged and if they are to go into storage (without being used), they will maintain 80% of their charge after 12 months. The units has a life expectancy of 5 to 7 years, if maintained properly.



# Section 6 – Troubleshooting and FAQ

## 6.1 – Frequently Asked Questions

### 1. Why should I buy a Tesla™ Turbo Start™ System?

Tesla™ Turbo Start™ is a multi-functional system that are ideal for support of 24 Vdc vehicles and aircraft and their electronics/avionics on the bench. Tesla™ manufactures various systems of different sizes and capacities that are man-portable, maintenance free and provide pure, dc power in a completely safe package. Designed for Military applications, these systems are equally valuable in maintenance support at the main facility or in remote locations. They are easily transported and air-portable. They will also provide 28.5 Vdc when the system is connected to the appropriate ac source.

### 2. How does a Turbo Start™ work?

The Turbo Start™ combines state of the art power conversion electronics with our proprietary “dry cell” batteries. The system’s electronics incorporate an intelligent charging system for the cells. The cells are ideal for this application as they are non-spillable, absorbed electrolyte dry cells that are sealed, maintenance free and safe for air transport.

### 3. How is Turbo Start™ used in Aviation Support?

There are many ways a Turbo Start™ will benefit your operation. By using it for pre-flight testing, you will avoid depleting the aircraft’s battery. You can start the aircraft’s engine with the Turbo Start™ as well. In the hangar, when connected to ac power, the Turbo Start™ will provide 28.5 Vdc for avionics testing and will also recondition and recharge the aircraft’s battery. Another benefit is the ability to fly with the Turbo Start™ aboard your aircraft. You may take the Turbo Start™ anywhere you travel, ensuring that you will always have power.

### 4. How much power will my Turbo Start™ provide?

Depending on the system, the Turbo Start™ will provide anywhere from 1500 to 3500 peak starting amps, 25 to 400 continuous amps dc and 23 to 96 hours of rechargeable power. See our website ([www.teslaind.com](http://www.teslaind.com)) to determine the proper Turbo Start™ for your needs.

### 5. Will a Tesla™ Turbo Start™ spool up a turbine engine?

Nothing will start a turbine engine faster or safer than the right Tesla™ Turbo Start™. Not only will it eliminate hot starts, but it will extend the life of your starter, your engine and your battery while reducing maintenance. The Turbo Start™ senses the impedance from the starter/generator. It then provides the exact power required throughout the start-up curve.

### 6. How many engine starts will my Turbo Start™ provide until it is depleted?

The Turbo Start™ back-charges, almost instantly, once the vehicle / aircraft is started and the generator is on line. This “power flywheel” feature enables the Turbo Start™ to recharge itself right from the vehicle it started in less than 30 seconds. You can go down the line in your motor pool and start every 24V vehicle, without limit!

### 7. How do you prolong the life of the Turbo Start’s cells?

All you need to do is plug the unit in to the appropriate ac power outlet the system requires. AC power will recharge the system and keep the cells healthy. Users who regularly plug the system in can expect to get 5-7 years from their cells before they need to be replaced. The recharging system will not overcharge the unit or produce excess heat.

### 8. Is it waterproof?

Water-resistant but not waterproof (See Environmental Section).

## 9. Are Tesla™ GPUs used in shop maintenance and testing?

Tesla™ systems are gaining popularity throughout maintenance facilities, instructional facilities, laboratories, manufacturing plants, aircraft hangars and many other locations. The reason is due to the precise dc power, the small, portable and quiet nature of our systems and the maintenance free aspect of our GPU's. We can custom tailor ground power systems to fit your individual requirements.

## 10. Can one person transport it?

Turbo Start™ is designed to be handled by one person. The TI500 is our smallest GPU system to date and weighs 36 lbs. The TI1000 weighs 57 Lbs and can be carried or wheeled on a dolly. Larger units have wheels incorporated directly on the system with an extendable handle.

## 11. Is the Turbo Start™ in the government purchasing system?

Yes. Tesla™ Industries is an approved vendor/supplier – our cage code is OVWE2. Most Tesla™ products are class IX, have a National Stock Number (NSN) designation and can be acquired through the DLA (Defense Logistics Agency).

## 12. How long does this unit stay charged?

Unit should never be allowed to discharge fully. In-field use, it receives a dc back charge directly from a running engine. When not in use, unit should be plugged into ac power (outlet) all the time. Tesla™ systems will retain 80% of their capacity after one year of storage.

## 13. How do I get my Turbo Start™ serviced?

Contact Tesla™. We can be reached at (302) 324-8910. Ask for customer service. You can also email us at [tesla1@teslaind.com](mailto:tesla1@teslaind.com). Once we receive the unit at our facility, we will examine it. Systems that are protected under warranty will be repaired at no charge. If the warranty has expired, you will receive a quote for necessary repairs prior to work being done. Our turnaround time is 48 hours once repairs are authorized.

## 14. Can I make my own repairs to unit?

During the warranty period, the unit can only be repaired by Tesla™ Industries for the warranty to remain in effect. Regardless, we strongly recommend allowing Tesla™ to repair any unit as we will analyze the complete system and recalibrate it.

## 15. What type of maintenance does the Turbo Start™ require?

Although the systems are maintenance free, please keep units plugged in while not in use. This will greatly extend the life of the cells. Also, keep the vent areas clean and free of debris. Keep units in a well ventilated area while charging. Keep the unit in a protected environment when not in use (maintenance facility, shed, etc.).

## 16. What is included with my Turbo Start™?

Aviation customers will receive an eight (8') foot DC Aviation Cable Assembly (TI2007-208). Ground vehicle customers will receive a fifteen (15') foot DC NATO Cable Assembly (TI2007-315). All customers receive an ac line cord for their home country and a full two year warranty.

## 17. Are there any HAZMAT issues or disposability problems?

There are none. Tesla™ will reclaim all battery cells for disposability purposes. Contact Tesla™ if you have questions.

## 6.2 - Basic Usage/Operation Questions

### 1. What's the best position to place the unit for use vertical or horizontal?

Preferred position is horizontal for stability and airflow considerations. When charging, the preferred position is horizontal. The Turbo Start™ can be put in any position while it is being used as there is nothing to spill inside the system.

### 2. Does the unit have to be plugged in all the time?

No, but for maximum performance and cell longevity, keep the unit plugged in while not in use.

### 3. What happens if I don't keep it plugged in?

Unit will eventually lose its charge and cell life is shortened.

### 4. How do I check the status of the charge?

Press the "Push to Test" LED bar indicator on the unit's faceplate. A fully charged unit will have one green LED light showing.

### 5. Why is the cooling fan always running when I am plugged into ac power?

Constant cooling fan operation ensures proper and consistent ventilation of the unit.

### 6. Why does the cooling fan slow down?

Cooling fan rpm varies for better temperature regulation.

### 7. Why does my LED flicker when the unit is plugged in?

Older Turbo Starts™ indicated a full charge with a flickering LED readout. Newer models feature the illumination of one green bar on the LED readout when the unit is fully charged.

### 8. What do I do if a circuit breaker trips?

The AC Input Circuit Breaker is located above the AC Input Connector. When the circuit breaker has been tripped, either of the red buttons will pop out. In the event that the breaker trips:

1. Disconnect the ac and dc connectors. (Unplug ac line cord on military unit.)
2. Wait for a minimum of 60 seconds.
3. Reset breaker by pressing red button.
4. Reconnect ac and dc connections to the unit. (Plug in ac line cord on military unit.)

The unit should power up automatically. If the breaker continues to trip, return the unit to Tesla™ Industries for repair.

### 6.3 - Basic Unit Troubleshooting

| Fault                                                          | Possible Cause                                                                                                                                                                                                                                   | Remedy                                                                                                                                                                                                                                                                     |
|----------------------------------------------------------------|--------------------------------------------------------------------------------------------------------------------------------------------------------------------------------------------------------------------------------------------------|----------------------------------------------------------------------------------------------------------------------------------------------------------------------------------------------------------------------------------------------------------------------------|
| 1. Output Capacity LED does not come on when button is pushed. | <p><b>A.</b> Units cells completely dead.</p>                                                                                                                                                                                                    | <p><b>A.</b> Plug the unit in to the appropriate ac power outlet and recharge.</p> <p><b>B.</b> If LEDs still do not illuminate, Please contact Tesla™ Customer Service at (302) 324-8910.</p>                                                                             |
| 2. Unit has no output dc or ac input or both.                  | <p><b>A.</b> Units cells completely dead.</p> <p><b>B.</b> AC line cord is damaged or bad.</p> <p><b>C.</b> DC line cord is damaged or bad.</p> <p><b>D.</b> AC circuit breaker has been tripped.</p> <p><b>E.</b> Cables loose or corroded.</p> | <p><b>A.</b> Do a function check with digital meter, see section 3.8.</p> <p><b>B.</b> Do continuity test.</p> <p><b>C.</b> No continuity, check cables for cuts and replace if needed.</p> <p><b>D.</b> Clean contacts of debris and make sure connections are tight.</p> |
| 3. Unit will not charge from ac outlet.                        | <p><b>A.</b> AC line cord is damaged or bad.</p> <p><b>B.</b> Is ac line cord fully plugged into unit and wall outlet.</p> <p><b>C.</b> AC circuit breaker has been tripped.</p> <p><b>D.</b> No ac power at outlet.</p>                         | <p><b>A.</b> Do a continuity test on the ac line cord</p> <p><b>B.</b> Check if line cord is properly secured.</p> <p><b>C.</b> Check to make sure ac circuit breaker is placed in the “ON” position.</p>                                                                  |
| 4. Unit failed function test.                                  | <p><b>A.</b> Internal failure.</p>                                                                                                                                                                                                               | <p><b>A.</b> Please contact Tesla™ Customer Service at (302) 324-8910.</p>                                                                                                                                                                                                 |
| 5. Unit emits sparks when plugged into power source.           | <p><b>A.</b> Water or moisture has seeped in unit</p> <p><b>B.</b> Internal failure.</p>                                                                                                                                                         | <p><b>A.</b> Move unit to dry warm air and allow to dry for over 48 hours.</p> <p><b>B.</b> Do Not Use Unit. Please contact Tesla™ Customer Service at (302) 324-8910.</p>                                                                                                 |
| 6. Unit works then shuts down.                                 | <p><b>A.</b> Unit is overheating.</p> <p><b>B.</b> Cooling fans and vents are obstructed or inoperable.</p>                                                                                                                                      | <p><b>A.</b> Move the unit to an area 10° -20° less ambient temperature.</p> <p><b>B.</b> Clean and clear cooling vents, turn on unit and inspect if air is flowing through unit. If no airflow please contact Tesla™ Customer Service at (302) 324-8910.</p>              |

| Fault                                              | Possible Cause                    | Remedy                                                                                                                                                                                                                                                    |
|----------------------------------------------------|-----------------------------------|-----------------------------------------------------------------------------------------------------------------------------------------------------------------------------------------------------------------------------------------------------------|
| 7. Circuit breaker continuously trips              | <b>A.</b> Unit is overheating.    | <b>A.</b> Disconnect unit from ac input and dc output.<br><b>B.</b> Switch breaker to ON position.<br><b>C.</b> Reconnect unit to cables and run.<br><b>D.</b> If LEDs still do not illuminate, Please contact Tesla™ Customer Service at (302) 324-8910. |
| 8. Unit does not put out 28.5 volts dc power.      | <b>A.</b> Unit is not plugged in. | <b>A.</b> Plug unit into ac power source to maintain 28.5.<br><b>B.</b> Stand alone Vdc is 24 Volts (unplugged).                                                                                                                                          |
| 9. Unit stand alone voltage is less than 23 volts. | <b>A.</b> Cells discharged.       | <b>A.</b> Plug unit into ac power source.<br><b>B.</b> Recheck capacity after 25 minutes.<br><b>C.</b> Failure to hold above 23 Vdc, Please contact Tesla™ Customer Service at (302) 324-8910.                                                            |
| 10. Unit weakens after first start.                | <b>A.</b> Weak cells.             | <b>A.</b> Allow between 30 to 60 seconds backcharge between uses.                                                                                                                                                                                         |

# Section 7 – Performance Data

## 7.1 – Purpose

This section provides performance data for the unit. Continual reference to this information will enable the user to obtain maximum performance, utilization and service life from the unit. Although maximum performance is not always required, regular referral to this section is recommended for the following reasons:

- A.** To generate knowledge of unit's performance margins to enable the operator to make sound judgment when unexpected conditions or alternate operational requirements are encountered.
- B.** To enable the user to readily recognize situations requiring maximum performance.
- C.** To gain experience in accurately estimating the effects of variables for which data is not presented.
- D.** To help the operator determine if a vehicle or an aircraft system malfunction exists by comparing actual performance with expected performance.



### NOTE

The information, in this section, provides data for operational planning. This is helpful when planning operations under unfamiliar conditions or environmental extremes. The data may also be used to establish local operating procedures and to ensure maximum usage of the unit.

## 7.2 – General

The data presented covers the maximum range of conditions and performance that can reasonably be expected. In each area of performance, the effects of temperature and dc electrical load demand relating to the ground power support requirements are presented. Wherever practical, data is presented conservatively. However, **NO GENERAL CONSERVATISM HAS BEEN APPLIED**. All performance data presented is within the applicable limits of the unit

## 7.3 – Data Basis

The type of data used is indicated at the bottom of each performance chart under **DATA BASIS**. The applicable report and date of the data are also given. The data provided generally are based on one of three categories:

- A.** Derived From Actual Controlled Testing: Controlled test data obtained on a similar unit type.
- B.** Calculated Data: Data based on tests, but not on a similar unit type placed under a controlled test.
- C.** Estimated Data: Data based on estimates using rules of physics, mathematics, and electrical engineering principles and concepts, but not verified by tests.

## 7.4 – Specific Conditions

The data presented are accurate only for specific conditions listed under the title of each chart or graph. Variables for which data are not presented, but which may affect that phase of performance, are discussed in associated text.

## 7.5 – General Conditions

In addition to the specific conditions, the following general conditions are applicable to the performance data.

- A.** Variation in Aircraft: Power demand differences between individual aircraft of the same make and model are known to exist due to variations in dc electrical system efficiency. These differences, however, are considered insignificant and are not individually accounted for.
- B.** Ground Support and Aircraft Instrument Variations: The data shown in the performance charts do not account for instrument tolerance differences or inaccuracies.

## 7.6 – Temperature Conversion Chart

| °C    | °F    | °C    | °F    | °C   | °F    | °C   | °F    |
|-------|-------|-------|-------|------|-------|------|-------|
| -60.0 | -76.0 | -27.0 | -16.6 | 6.0  | 42.8  | 39.0 | 102.2 |
| -59.0 | -74.2 | -26.0 | -14.8 | 7.0  | 44.6  | 40.0 | 104.0 |
| -58.0 | -72.4 | -25.0 | -13.0 | 8.0  | 46.4  | 41.0 | 105.8 |
| -57.0 | -70.6 | -24.0 | -11.2 | 9.0  | 48.2  | 42.0 | 107.6 |
| -56.0 | -68.8 | -23.0 | -9.4  | 10.0 | 50.0  | 43.0 | 109.4 |
| -55.0 | -67.0 | -22.0 | -7.6  | 11.0 | 51.8  | 44.0 | 111.2 |
| -54.0 | -65.2 | -21.0 | -5.8  | 12.0 | 53.6  | 45.0 | 113.0 |
| -53.0 | -63.4 | -20.0 | -4.0  | 13.0 | 55.4  | 46.0 | 114.8 |
| -52.0 | -61.6 | -19.0 | -2.2  | 14.0 | 57.2  | 47.0 | 116.6 |
| -51.0 | -59.8 | -18.0 | -0.4  | 15.0 | 59.0  | 48.0 | 118.4 |
| -50.0 | -58.0 | -17.0 | 1.4   | 16.0 | 60.8  | 49.0 | 120.2 |
| -49.0 | -56.2 | -16.0 | 3.2   | 17.0 | 62.6  | 50.0 | 122.0 |
| -48.0 | -54.4 | -15.0 | 5.0   | 18.0 | 64.4  | 51.0 | 123.8 |
| -47.0 | -52.6 | -14.0 | 6.8   | 19.0 | 66.2  | 52.0 | 125.6 |
| -46.0 | -50.8 | -13.0 | 8.6   | 20.0 | 68.0  | 53.0 | 127.4 |
| -45.0 | -49.0 | -12.0 | 10.4  | 21.0 | 69.8  | 54.0 | 129.2 |
| -44.0 | -47.2 | -11.0 | 12.2  | 22.0 | 71.6  | 55.0 | 131.0 |
| -43.0 | -45.4 | -10.0 | 14.0  | 23.0 | 73.4  | 56.0 | 132.8 |
| -42.0 | -43.6 | -9.0  | 15.8  | 24.0 | 75.2  | 57.0 | 134.6 |
| -41.0 | -41.8 | -8.0  | 17.6  | 25.0 | 77.0  | 58.0 | 136.4 |
| -40.0 | -40.0 | -7.0  | 19.4  | 26.0 | 78.8  | 59.0 | 138.2 |
| -39.0 | -38.2 | -6.0  | 21.2  | 27.0 | 80.6  | 60.0 | 140.0 |
| -38.0 | -36.4 | -5.0  | 23.0  | 28.0 | 82.4  | 61.0 | 141.8 |
| -37.0 | -34.6 | -4.0  | 24.8  | 29.0 | 84.2  | 62.0 | 143.6 |
| -36.0 | -32.8 | -3.0  | 26.6  | 30.0 | 86.0  | 63.0 | 145.4 |
| -35.0 | -31.0 | -2.0  | 28.4  | 31.0 | 87.8  | 64.0 | 147.2 |
| -34.0 | -29.2 | -1.0  | 30.2  | 32.0 | 89.6  | 65.0 | 149.0 |
| -33.0 | -27.4 | 0.0   | 32.0  | 33.0 | 91.4  | 66.0 | 150.8 |
| -32.0 | -25.6 | 1.0   | 33.8  | 34.0 | 93.2  | 67.0 | 152.6 |
| -31.0 | -23.8 | 2.0   | 35.6  | 35.0 | 95.0  | 68.0 | 154.4 |
| -30.0 | -22.0 | 3.0   | 37.4  | 36.0 | 96.8  | 69.0 | 156.2 |
| -29.0 | -20.2 | 4.0   | 39.2  | 37.0 | 98.6  | 70.0 | 158.0 |
| -28.0 | -18.4 | 5.0   | 41.0  | 38.0 | 100.4 | 71.0 | 159.8 |

7.7 – Output Voltage

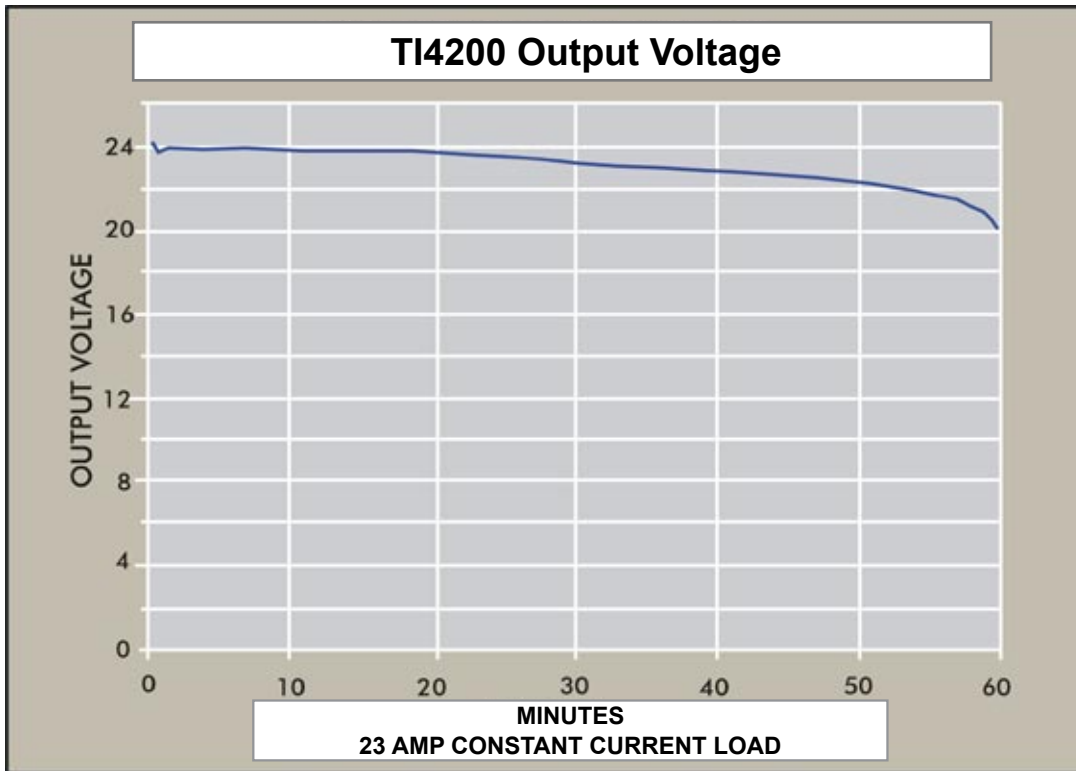

7.8 – Maximum Output Current

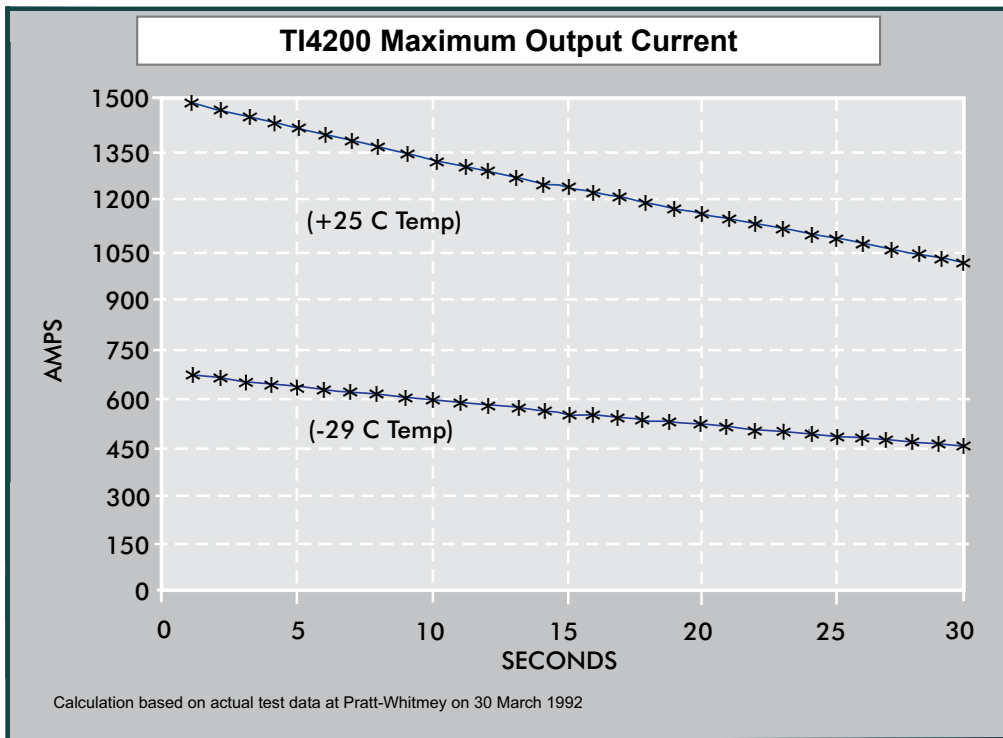



## Section 8 – Optional Accessories

### 8.1 – Shipping Case

The optional Shipping Case is the safest way to transport the TI4200 GPU-24-PFC. This custom case weighs 95 lbs and comes equipped with side handles and locking latches.

#### **TI7000-175**

Length: 54.5" (1384.3 mm)  
Width: 23.5" (596.9 mm)  
Height: 20.5" (520.7 mm)  
Weight: 95 lbs (43.09 kg)



### 8.2 – GPU Protective Covers

Protective unit from moisture, sand and other damaging elements. Custom fit for the TI4200 GPU-24-PFC.

#### **TI7000-104**



### 8.3 – Digital Volt/Amp Meter (TI3100A)

The Tesla™ Digital Volt Amp Meter is a high powered measuring solution. The DVAM 3100A provides measurements for DC voltage from 12 to 32 V and DC current up to 2000 amps for Aircraft and vehicle. Integrated with the Tesla™ Turbo Start™ GPU power supply, the DVAM is a valuable tool for troubleshooting and conducting systems checks. The DVAM 3100A can be ordered through customer service at Tesla™.

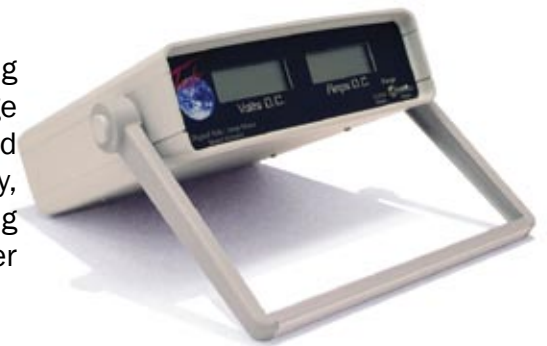

### 8.4 – GPU Tires

Tesla™ offers several tires in order to meet various customer mobility needs.



#### **TI21000-203**

##### Run-Flat Tire

A solid foam rubber tire. The standard tire for ground power units.



#### **TI21000-237**

##### Run-flat Hybrid Tire

A rugged, puncture-proof, foam-filled tire sized to fit our Hybrid units.



#### **TI21000-192**

##### Balloon Tire

For use on soft sand.

### 8.5 – Cobra™ DC Replacement Contacts and Tools

Cobra™ DC Plugs provide reliable high-power connections up to 3000 amps – even in the harshest conditions. A rugged combination of advanced composite materials and corrosion-resistant alloys make each plug maximized for durability and connectivity. To extend the life of the Cobra™ Connector included with your unit, replacement contacts, posts, noses and tools can be ordered through the Tesla™ Customer Service.

TI2005-238

Cobra™ Aviation Plug



TI2005-078

Cobra™ NATO Connector  
NSN: 6130-01-523-1270 (CL IX)



TI2005-251

DC Aviation Plug  
Positive/Negative  
Contact



TI2005-654

DC 400Hz Aviation Plug  
Positive/Negative  
Contact



TI2004-444

NATO Replacement Post  
For newer NATO plugs with new style post, indicated by the black tip. Replacement plug uses standard 3/4" deep well socket for installation.



TI2005-250

DC Aviation Plug  
3-slotted Connector



TI2005-239

Aviation Insertion/  
Extraction Tool



TI2005-121

NATO Negative Contact  
NSN: 5999-01-525-0582 (CL IX)



TI2005-117

NATO Positive Post  
NSN: 5935-01-523-8914 (CL IX)



TI2004-341

Replacement Nose for  
Aviation Plug



TI2004-340

Replacement Nose for  
400Hz Aviation Plug



TI2005-126

NATO Negative Contact  
Insertion/Extraction Tool  
NSN: 5120-01-523-8761 (CL II)



TI27000-082

NATO Positive Contact  
Insertion/Extraction Tool  
NSN: 5120-01-527-7729 (CL II)



# Repair Request Form

Please complete the information below to ensure prompt and accurate service. Include this form with the unit you are returning. Thank you.

Date of return: \_\_\_\_\_

Company name & \_\_\_\_\_  
\_\_\_\_\_  
\_\_\_\_\_

Billing address: \_\_\_\_\_  
\_\_\_\_\_  
\_\_\_\_\_

Contact person: \_\_\_\_\_

Phone #: \_\_\_\_\_ Fax #: \_\_\_\_\_

Email: \_\_\_\_\_

Purchase Order #: \_\_\_\_\_

Model #: \_\_\_\_\_ Serial #: \_\_\_\_\_

Model #: \_\_\_\_\_ Serial #: \_\_\_\_\_

Shipping method to Tesla™: \_\_\_\_\_

Description of shipping package: \_\_\_\_\_

Description of problem: \_\_\_\_\_

\_\_\_\_\_  
\_\_\_\_\_  
\_\_\_\_\_

## Return to Tesla™

101 Centerpoint Boulevard, New Castle, DE 19720 Attention: Repair Department



**WE GET THE MILITARY STARTED!**

**Tesla™**

101 Centerpoint Blvd.  
New Castle, DE 19720 USA  
Tel: 302-324-8910  
Fax: 302-324-8912

9475 Double R Blvd., Suite 2  
Reno, NV 89521  
Tel: 775-622-8801  
Fax: 775-622-8810

[www.teslaind.com](http://www.teslaind.com) ♦ [www.tesla1.com](http://www.tesla1.com)